



Three phase motor choke
VLXM300
300A 0.04mH,
suitable for drives
size 90...110kW

Product designation

Product type designation

Version

General characteristics

Rated current (Ie)	A	300
Inductance	mH	0.04
Rated power	VA	3390
Rated output current	A	300
Rated output power	kW	90...110

Technical features

Rated mains voltage	VAC	400
Operating mains voltage range	VAC	170...530
Rated mains frequency	Hz	50/60
Saturation current		1.5*Ie
Power loss		180W
THD		40%

Ambient conditions

Temperature

Operating temperature

	max	°C	+40
Max altitude		m	1000
Insulation class			Class F
Working class			Class F

Housing

Material		Alluminium
Installation position		Vertical
IP degree of protection		IP00
Dimensions (W x H x D)	mm	300x140x260
Weight	Kg	29

Dimensions

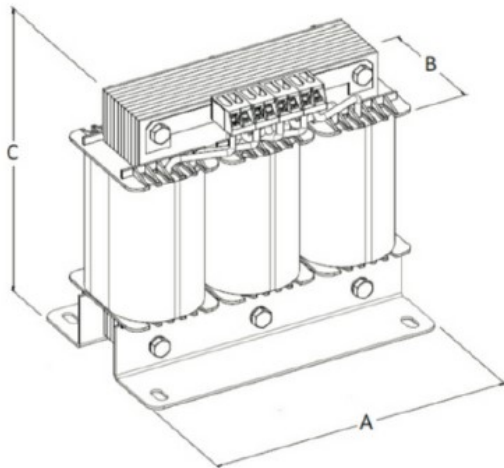

	VLXM012	VLXM025	VLXM050	VLXM100	VLXM150	VLXM300
A	150	180	180	250	240	300
B	75	90	100	150	160	140
C	150	160	200	205	205	260

Wiring diagrams

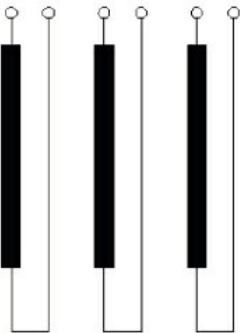

Certifications and compliance

Compliance

IEC/EN/BS 61558-1

ETIM classification

ETIM 8.0

EC002025