



Product designation	Modular switching power supplies		
Product type designation	PSL1M		
<b>Input characteristics</b>			
Input type	Single-phase		
Rated supply voltage AC	VAC	Multivoltage 100...240	
Operating range			
AC	min	VAC	90
	Max	VAC	264
DC	min	VDC	120
	Max	VDC	375
Rated frequency		Hz	50/60
Operational frequency	min	Hz	47
	max	Hz	63
Current consumption Max		mA	900
PFC	No		
Insulation voltage Input/Output	AC	VAC	3000
	DC	VAC	4242
Internal fuse (250VAC)	T2A 250VAC		
<b>Output characteristics</b>			
Rated output voltage DC		VDC	24
Voltage trimming (potentiometer) DC	min	VDC	24
	Max	VDC	28
Rated output current		A	1.5
Rated output power		W	36
Temperature coefficient		%/°C	±0.03
Line adjustment		%	±1
Load adjustment		%	±1
Efficiency		%	84
Overload protection	110...150%		
Short-circuit protection	Fold forward		
Ripple & noise		mV	50
Parallel connection		Nr.	No
<b>Indications</b>			
LED indicator for power on	Yes		
LED indicator for low voltage	Yes		
<b>Connections</b>			
Terminals type	Screw		
<b>Ambient conditions</b>			

Temperature

Operating temperature

min	°C	-40
max	°C	+71

Storage temperature

min	°C	-40
max	°C	+85

Derating

%/°C	2.5%/°C above 56°C
------	--------------------

**Housing**

Execution (n° of modules)

3

Material

Plastic

IEC degree of protection

IP20

Dimensions (W x H x D)

mm 53 x 96 x 56.2

Weight

g 248

**Installations**

Mounting

On 35mm DIN rail

**Dimensions**

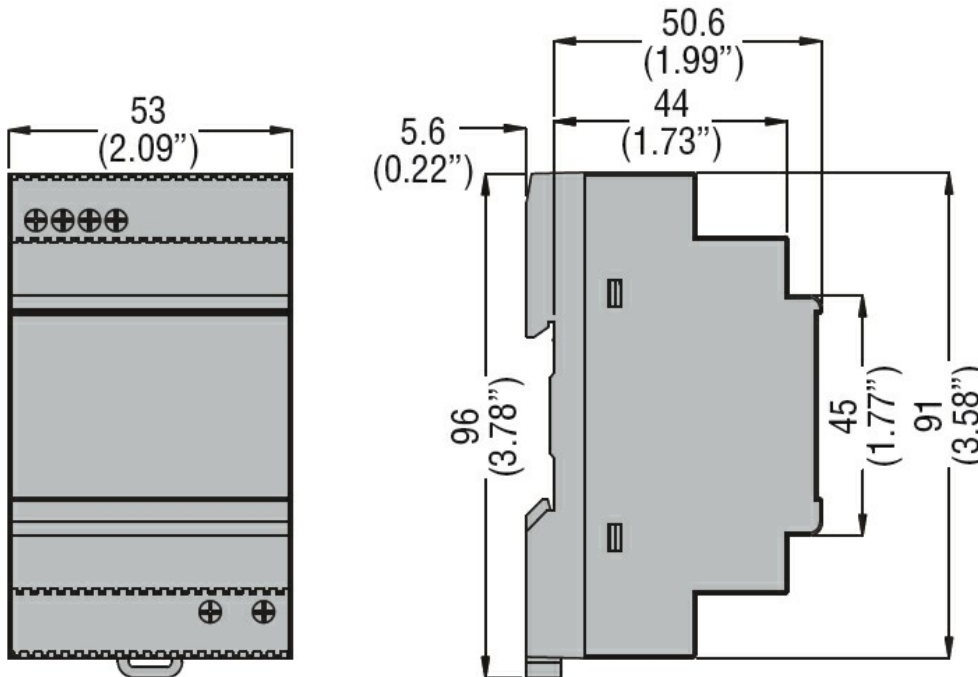

**Wiring diagrams**

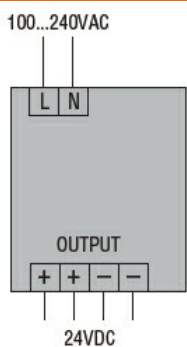

**Certifications and compliance**

Compliance

CSA C22.2 n°14

---

IEC/EN/BS 61000-6-2

---

IEC/EN/BS 61000-6-3

---

IEC/EN/BS 62368-1

---

UL 508

---

Certificates

cULus

---

EAC

---

RCM

---

ETIM classification

ETIM 8.0

EC002540 - DC-  
power supply