

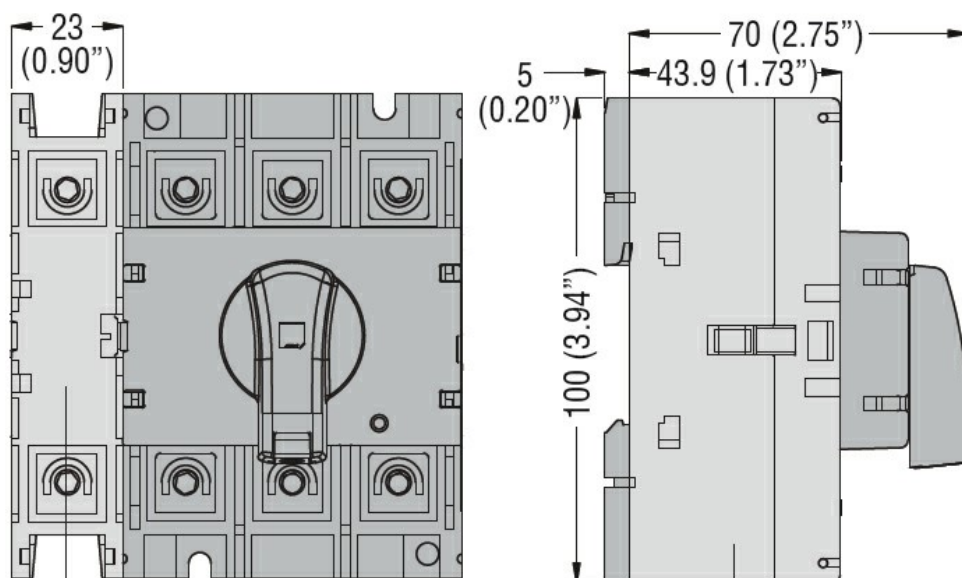

Numărul de poli	Nr.	1
Tip tensiune de operare		AC
Caracteristicile contactului		
Curent termic convențional în aer liber Ith IEC	A	100
Caracteristici mecanice		
Cuplu de strângere pentru terminale	min	Nm 5
	max	Nm 6
	min	Ibin 45
	max	Ibin 54

Dimensiuni



GAX41 125A, GAX42 063A... GAX42 160A,
GAX32 A, GAX34 A

Diagrame de cablare

Fourth pole add on
GAX42... **GAX41...**

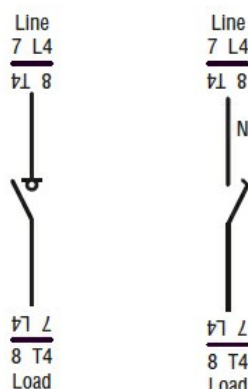

Certificari si conformitate

Conformitate

CSA C22.2

IEC/EN 60947-1

IEC/EN 60947-3

UL508

UL98

Certificari

CCC

CSA C22.2 n°4

cULus according to UL98

EAC

Clasificare ETIM

ETIM 8.0

EC002498 -
Accesorii pentru
dispozitive de
comutare de
joasă tensiune