



Switch
disconnecter with
fuse
GM

Product designation

Product type designation

Type of fuse

Number of poles

Operating voltage type

Nr. 3
AC

Contact characteristics

IEC Conventional free air thermal current I _{th}	A	100
Rated insulation voltage U _i IEC/EN	V	1000
Rated impulse withstand voltage U _{imp}	kV	12

Operating current I_e

AC21A	400V	A	160
	500V	A	160
	690V	A	160
AC22A	400V	A	160
	500V	A	160
	690V	A	160
AC23A	400V	A	160
	500V	A	160
	690V	A	160

Power dissipation per pole max	W	9
--------------------------------	---	---

Power dissipation per pole without fuse	W	9
---	---	---

Max fuse power dissipation	in open air	W	12
	in enclosure	W	12

Rated operational power AC23A	400V	kW	75
	690V	kW	132

Rated short time current (1s) I _{cw} (rms)	kA	5
---	----	---

Short-circuit protection with fuse	Class/A	J/100
------------------------------------	---------	-------

Making capacity AC23A 400V	A	1600
----------------------------	---	------

Breaking capacity AC23A 400V	A	1280
------------------------------	---	------

Mechanical life	cycles	8000
-----------------	--------	------

Electrical life AC21A	cycles	6000
-----------------------	--------	------

Mechanical features

Operating position	normal	Vertical plan
	allowable	Any

Fixing	Screw
--------	-------

Terminals	type	Bar
-----------	------	-----

Tightening torque for terminals

max	Nm	13.5
max	Ibin	10

Tightening torque for fuse links bolts

Nm	4
----	---

Tightening torque for terminal lug

Nm	5.5
----	-----

Terminal kit lugs

GMX500

UL technical data

UL Standard

UL98

General purpose current rating

A	100
---	-----

Operating voltage max

V	600
---	-----

Horsepower/FLA current three phase motor

240V	HP	30/80
480V	HP	60/77
600V	HP	75/77

Short circuit rating

kA rms	200
--------	-----

Short circuit rating with fuse

Class/A	J/100
---------	-------

Ambient conditions

Operating temperature

min	°C	-25
max	°C	55

Storage temperature

min	°C	-40
max	°C	70

Max altitude

m	3000
---	------

Resistance & Protection

Frontal IP degree

IP20

Pollution degree

3

Dimensions

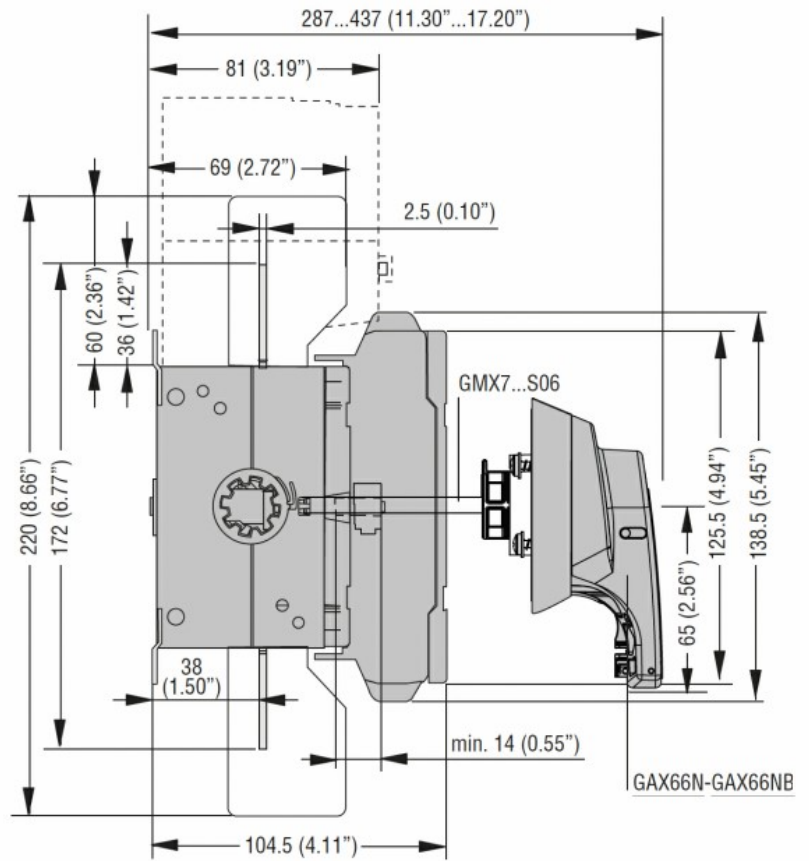
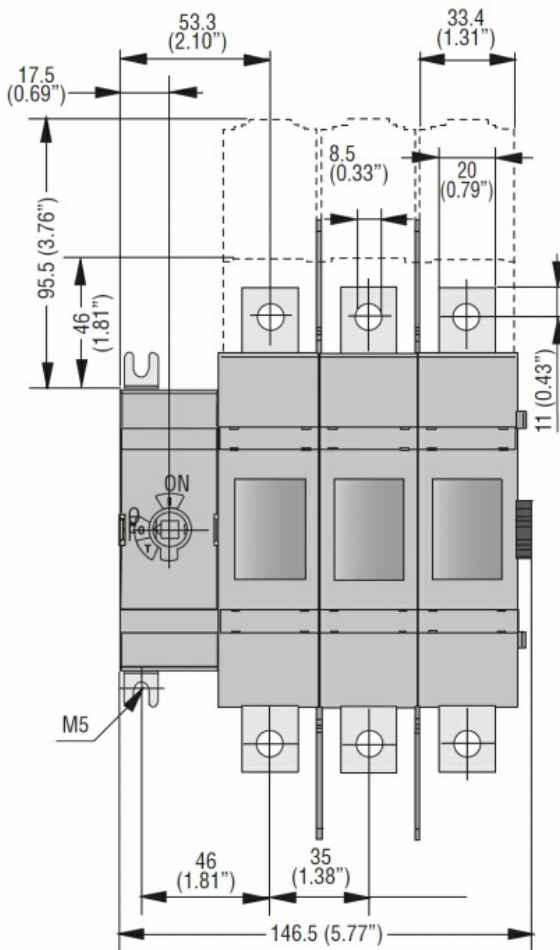

Wiring diagrams

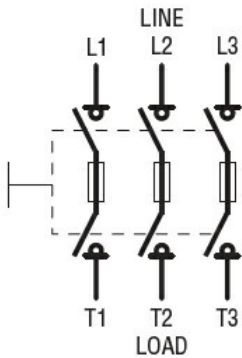

Certifications and compliance

Compliance

IEC/EN 60947-1
IEC/EN 60947-3

Certifications

cULus according to UL98/CSA C22.2 n°4

ETIM classification

ETIM 8.0

EC000216 -
Switch
disconnecter