



Product designation				Switch disconnecter
Product type designation				GLD
Number of poles		Nr.	2	
Operating voltage type				DC
Contact characteristics				
IEC Conventional free air thermal current I _{th}		A	315	
Rated insulation voltage U _i IEC/EN		V	1000	
Operating current I _e				
	DC21B			
		600V	A	315
		800V	A	315
		1000V	A	250
DCPV1				
		Operating current I _e 600V	A	315
		Operating current I _e 800V	A	315
	DCPV1			
		600V	A	315
		800V	A	315
Mechanical features				
Operating position		normal allowable	Vertical plan Any	
Fixing				Screw / DIN rail 35mm
Terminals		type	M8 x 25	
Tightening torque for terminals				
		min	Nm	15
		max	Nm	22
		min	lbin	132
		max	lbin	194
Conductor section				
		IEC min	mm ²	70
		IEC max	mm ²	185
		AWG/kcmil min		00
		AWG/kcmil max		400
Ambient conditions				
Operating temperature				
		min	°C	-25
		max	°C	+55
Storage temperature				
		min	°C	-40
		max	°C	+70
Max altitude			m	3000
Resistance & Protection				

Pollution degree

3

Dimensions

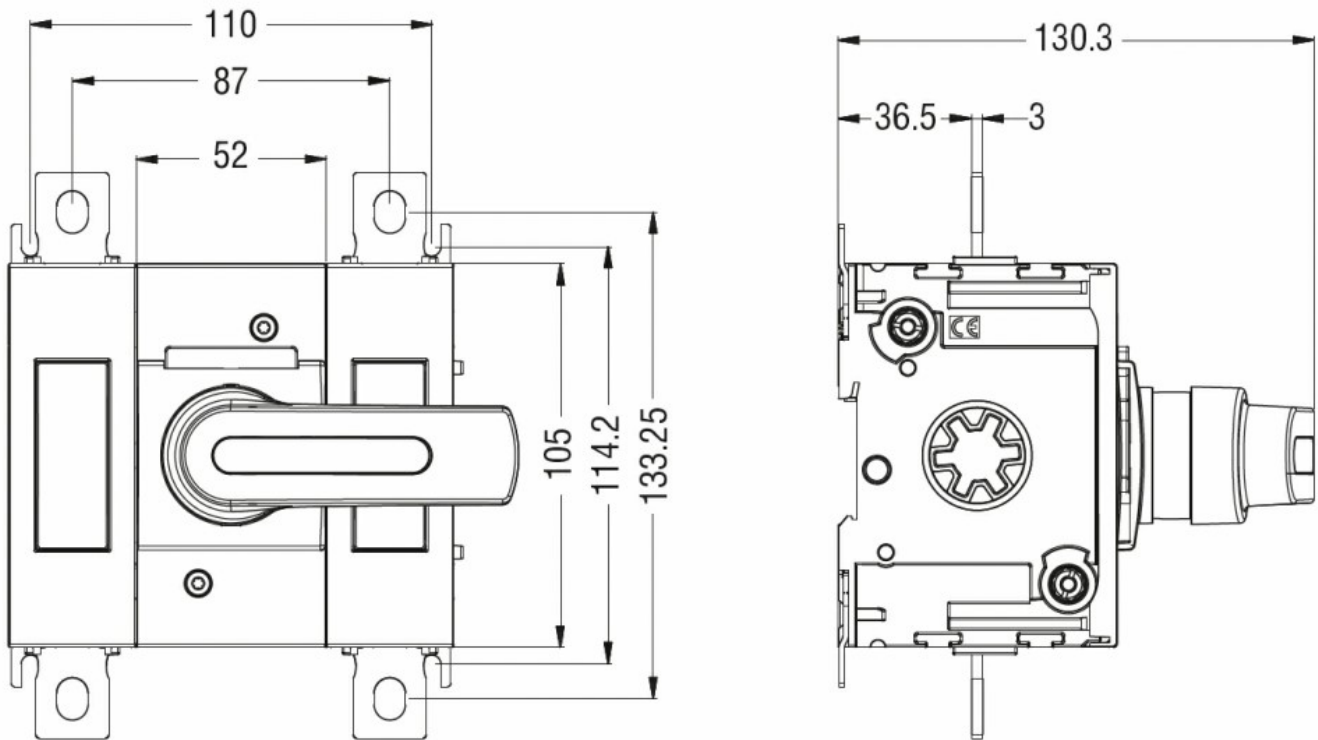

Wiring diagrams

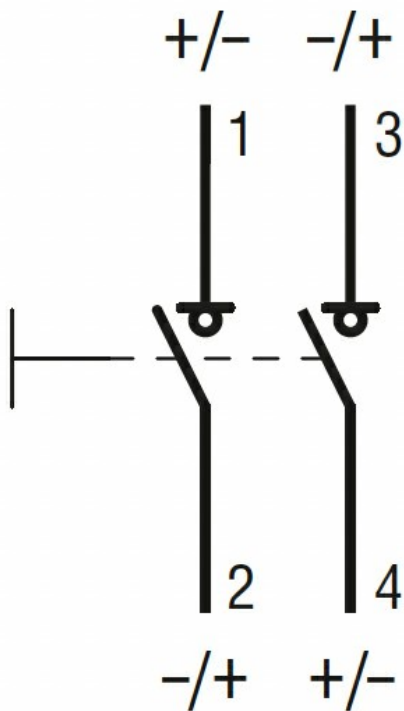

Certifications and compliance

Compliance

IEC/EN/BS 60947-1

IEC/EN/BS 60947-3

UL98B

Certifications

CE

ETIM classification

ETIM 8.0

EC000216 -
Switch
disconnecter