

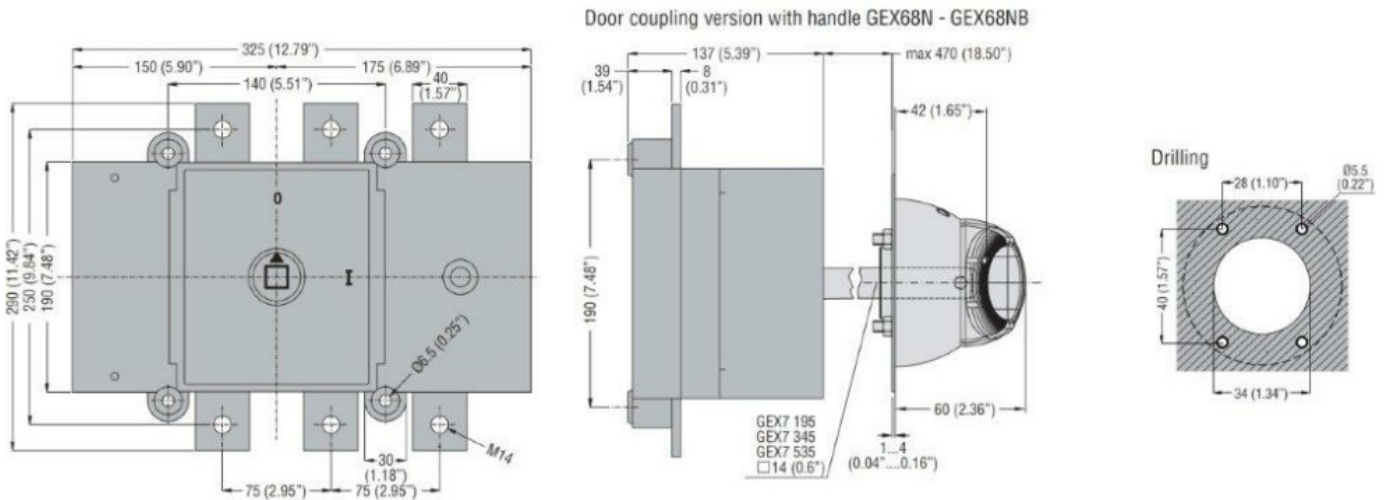

Product designation				Switch disconnecter
Product type designation				GE
Number of poles				Nr. 3
Operating voltage type				AC
Contact characteristics				
IEC Conventional free air thermal current I _{th}				A 1250
Rated insulation voltage U _i IEC/EN				V 1000
Rated impulse withstand voltage U _{imp}				kV 12
Operating current I _e				
AC21A	400V	A	1250	
	500V	A	1250	
	690V	A	1000	
AC22A	400V	A	1250	
	500V	A	1000	
	690V	A	630	
AC23A	400V	A	1000	
	500V	A	800	
	690V	A	500	
Power dissipation per pole max				W 78
Rated operational power AC23A	400V	kW	443	
	690V	kW	478	
Rated short time current (1s) I _{cw} (rms)				kA 25
Conditional short-circuit current (rms)				kA 72
Short-circuit protection with fuse				Class/A gG1250
Making capacity AC23A 400V				A 8000
Breaking capacity AC23A 400V				A 6400
Mechanical life				cycles 10000
Electrical life AC21A				cycles 500 (AC23A 400V)
Mechanical features				
Operating position	normal allowable	Vertical plan Any		
Fixing				Screw
Terminals	type screw	Bar M14		
Tightening torque for terminals	max	Nm	45	
	max	Ibin	10	

Bar dimensions max	40x8		
Ambient conditions			
Operating temperature	min	°C	-25
	max	°C	55
Storage temperature			
	min	°C	-40
	max	°C	70
Max altitude	m	3000	
Resistance & Protection			
Frontal IP degree	IP20		
Pollution degree	3		
Dimensions			



Wiring diagrams

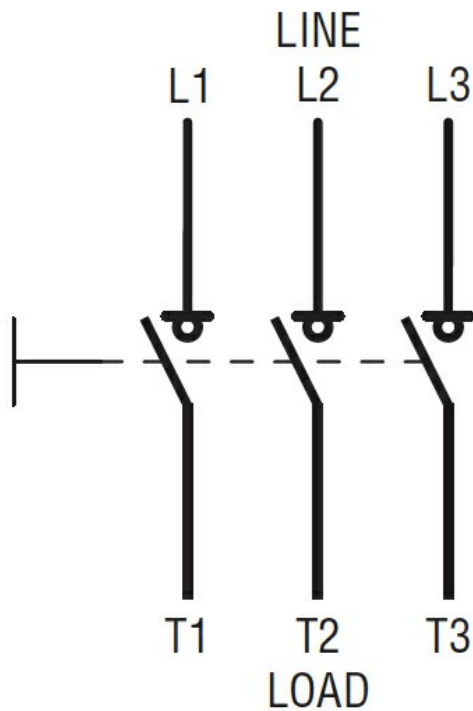

Certifications and compliance

Compliance

IEC/EN 60947-1
IEC/EN 60947-3

Certifications

EAC

ETIM classification

ETIM 8.0

EC000216 -
Switch
disconnector