



Product designation	Switch disconnecter		
Product type designation	GE		
Number of poles	Nr.	4	
Operating voltage type	DC		
Contact characteristics			
IEC Conventional free air thermal current I _{th}	A	800	
Rated insulation voltage U _i IEC/EN	V	1000	
Rated impulse withstand voltage U _{imp}	kV	12	
Operating current I _e	4 poles in series DC21A		
	48V	A	800
	110V	A	800
	220V	A	800
	400V	A	800
	440V	A	750
	500V	A	700
	600V	A	700
	750V	A	650
	800V	A	630
	850V	A	630
	900V	A	630
	1000V	A	630
Rated short time current (1s) I _{cs} (rms)	kA	25000	
Mechanical life	cycles	10000	
Mechanical features			
Operating position	normal allowable	Vertical plan Any	
Fixing	Screw		
Terminals	type screw	Bar M10	
Tightening torque for terminals	max	I _{bin}	18
Bar dimensions max	30x5		
Ambient conditions			
Operating temperature	min	°C	-25
	max	°C	55
Storage temperature	min	°C	-40
	max	°C	70
Max altitude	m		3000
Resistance & Protection			

Frontal IP degree

IP20

Pollution degree

3

Dimensions

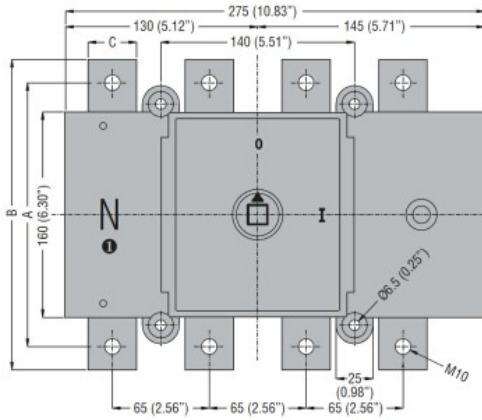

Type	A	B	C
GE0500 T4	190 (7.48")	220 (8.66")	25 (0.98")
GE0630 DT4	205 (8.07")	235 (9.25")	30 (1.18")
GE0630 T4	205 (8.07")	235 (9.25")	30 (1.18")
GE0800 DT4	205 (8.07")	235 (9.25")	30 (1.18")
GE0800 T4	205 (8.07")	235 (9.25")	30 (1.18")

Direct operating version with handle GEX67ND

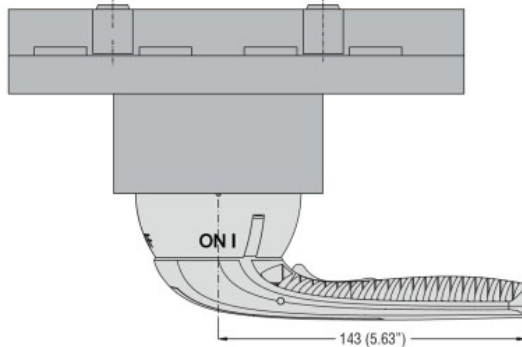

Door coupling version with handle GEX67N - GEX67NB

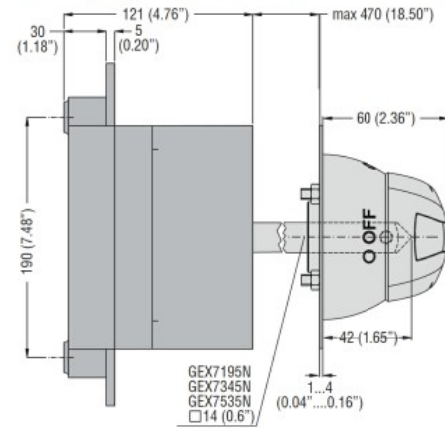

Drilling

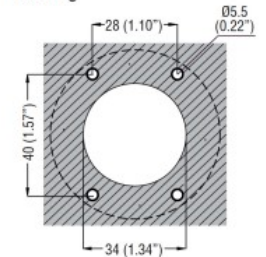

Wiring diagrams

One-line control
4 poles in series

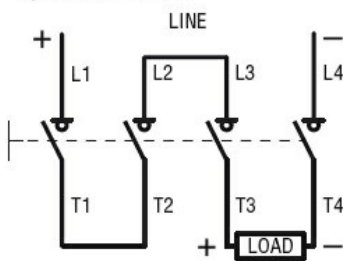

4 (2+2) poles in series

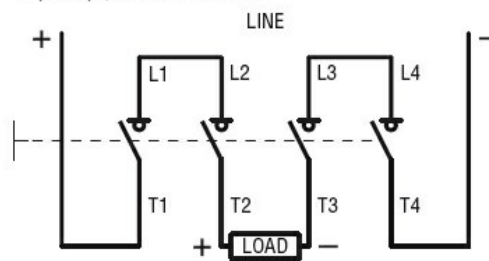

Certifications and compliance

Compliance

IEC/EN 60947-1
IEC/EN 60947-3

Certifications

EAC

ETIM classification

ETIM 8.0

EC000216 -
Switch
disconnecter