



Product designation				Switch disconnecter with fuse
Product type designation				GE
Type of fuse				BS
Number of poles	Nr.			3
Operating voltage type				AC
Contact characteristics				
IEC Conventional free air thermal current I _{th}	A			630
Rated insulation voltage U _i IEC/EN	V			1000
Rated impulse withstand voltage U _{imp}	kV			12
Operating current I _e				
AC21A	400V	A	630	
	500V	A	630	
	690V	A	630	
AC22A	400V	A	630	
	500V	A	630	
	690V	A	630	
AC23A	400V	A	630	
	500V	A	630	
	690V	A	400	
Power dissipation per pole max	W			44
Rated operational power AC23A	400V	kW	355	
	690V	kW	370	
Conditional short-circuit current (rms)	kA			100
Specific let through energy I ² t	kA ² s			4.6
Making capacity AC23A 400V	A			6300
Breaking capacity AC23A 400V	A			5100
Mechanical life	cycles			5000
Electrical life AC21A	cycles			1000 (AC23A 400V)
Mechanical features				
Operating position	normal allowable			Vertical plan Any
Fixing				Screw
Terminals	type screw			Bar M12
Tightening torque for terminals	max	Nm	45	
	max	lbin	33	

Bar dimensions max 40x6

Ambient conditions

Operating temperature
min °C -25
max °C 55

Storage temperature
min °C -40
max °C 70

Max altitude m 3000

Resistance & Protection

Frontal IP degree IP20

Pollution degree 3

Dimensions

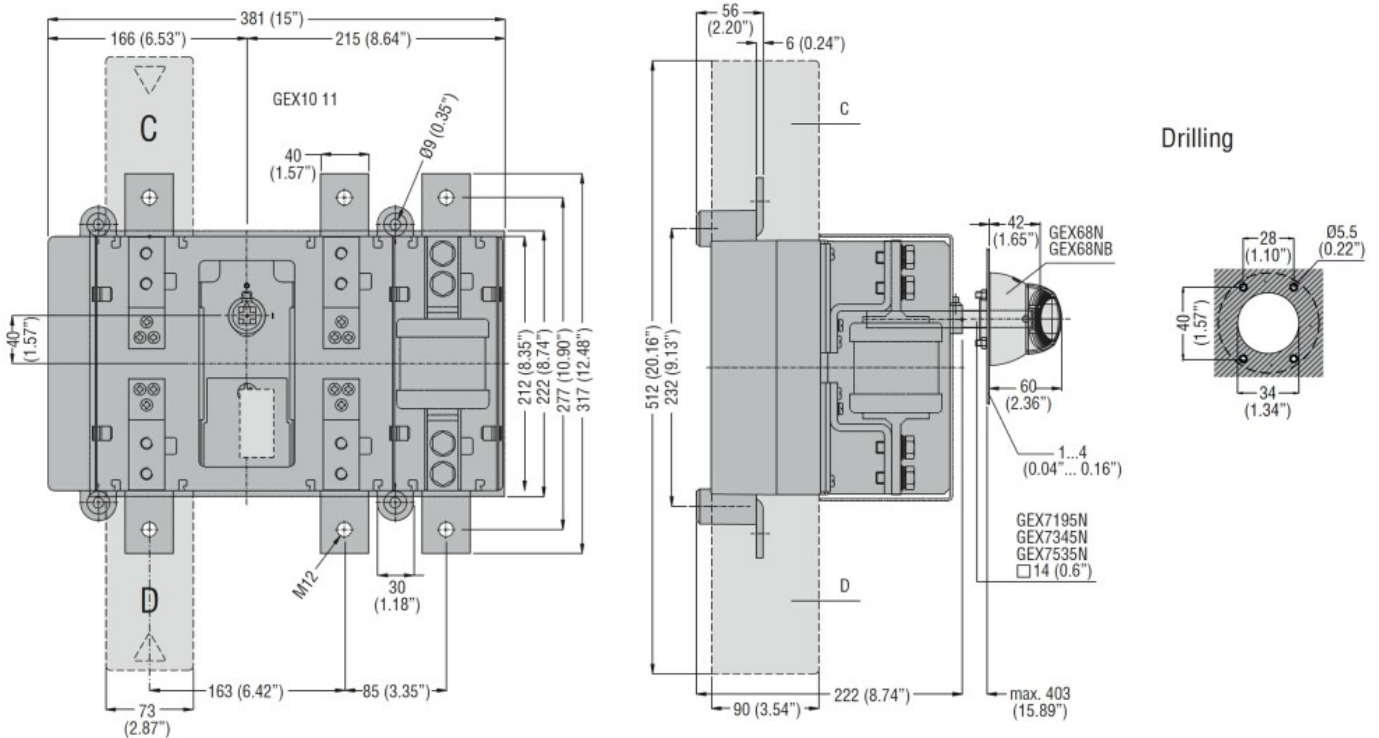

Wiring diagrams

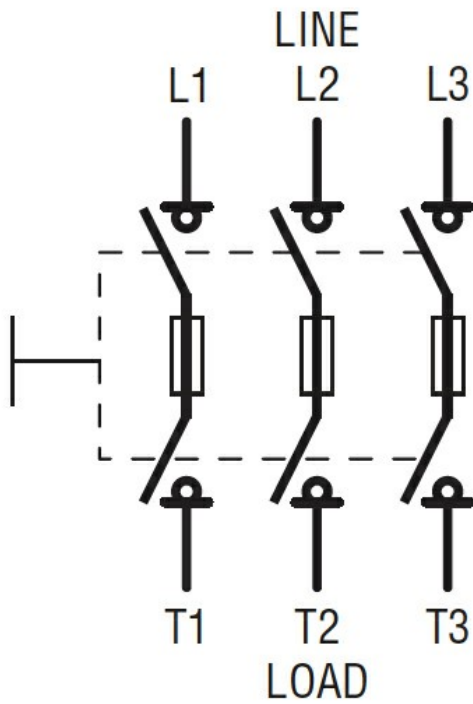

Certifications and compliance

Compliance

IEC/EN 60947-1

IEC/EN 60947-3

Certifications

EAC

ETIM classification

ETIM 8.0

EC000216 -
 Switch
 disconnecter