

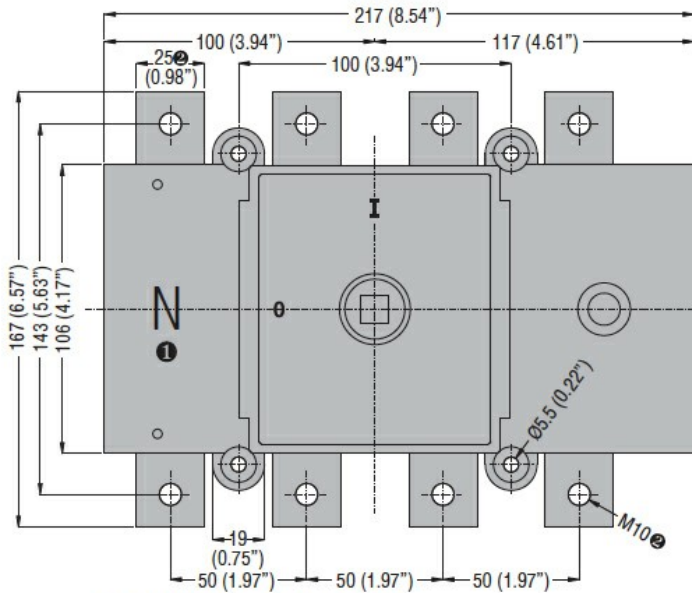

Product designation	Switch disconnecter		
Product type designation	GE		
Number of poles	Nr.	4	
Operating voltage type	DC		
Contact characteristics			
IEC Conventional free air thermal current I _{th}	A	315	
Rated insulation voltage U _i IEC/EN	V	1000	
Rated impulse withstand voltage U _{imp}	kV	8	
Operating current I _e	4 poles in series DC21A		
	48V	A	315
	110V	A	315
	220V	A	315
	400V	A	315
	440V	A	315
	500V	A	315
	600V	A	315
	750V	A	290
	800V	A	280
	850V	A	270
	900V	A	260
	1000V	A	250
Rated short time current (1s) I _{cs} (rms)	kA		25000
Mechanical life	cycles		20000
Mechanical features			
Operating position	normal allowable	Vertical plan Any	
Fixing	Screw		
Terminals	type screw	Bar M10	
Tightening torque for terminals	max	I _{bin}	13
Bar dimensions max	25x4		
Ambient conditions			
Operating temperature	min	°C	-25
	max	°C	55
Storage temperature	min	°C	-40
	max	°C	70
Max altitude	m		3000
Resistance & Protection			

Frontal IP degree	IP20
Pollution degree	3

Dimensions



- ❶ Not indicated on GE... DT4 type.
- ❷ 20mm (0.79") and M8 for GE0125 DT4 type.

**Door coupling version with handle
GEX66N - GEX66NB**

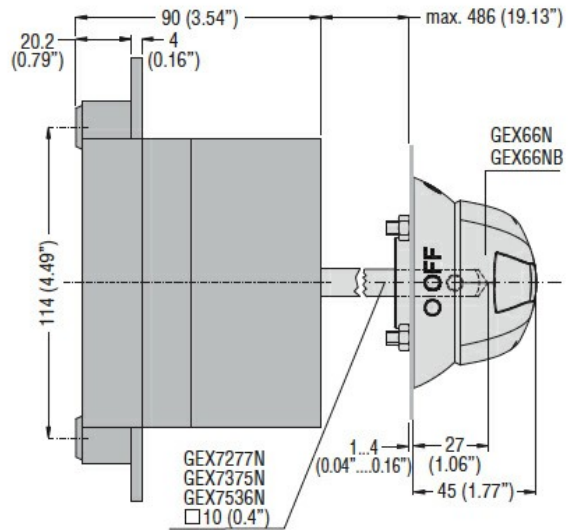

**Direct operating version with handle
GEX66ND**

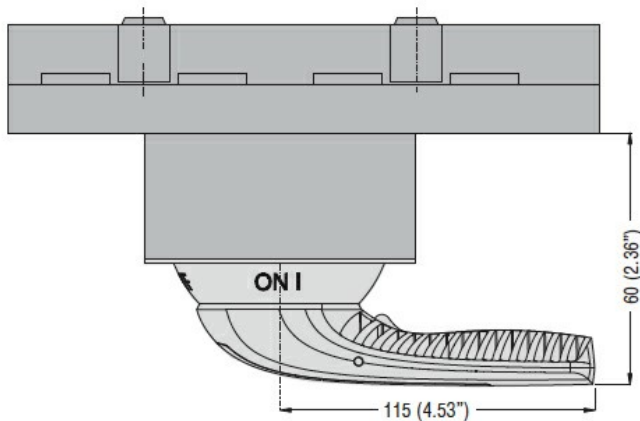

Wiring diagrams

**One-line control
4 poles in series**

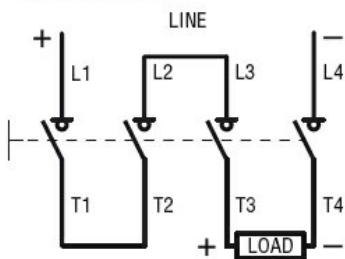

4 (2+2) poles in series

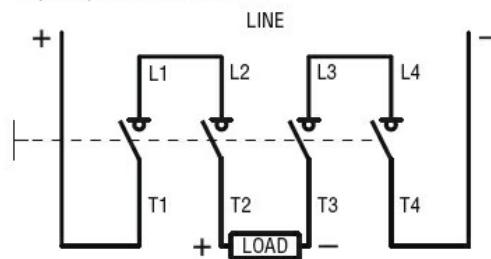

Certifications and compliance

Compliance

IEC/EN 60947-1

IEC/EN 60947-3

Certifications

EAC

ETIM classification

ETIM 8.0

EC000216 -
Switch
disconnecter