



Product designation				Switch disconnecter with fuse
Product type designation				GE
Type of fuse				BS
Number of poles	Nr.			3
Operating voltage type				AC
Contact characteristics				
IEC Conventional free air thermal current I _{th}	A			315
Rated insulation voltage U _i IEC/EN	V			1000
Rated impulse withstand voltage U _{imp}	kV			12
Operating current I _e				
AC21A	400V	A	315	
	500V	A	315	
	690V	A	315	
AC22A	400V	A	315	
	500V	A	315	
	690V	A	315	
AC23A	400V	A	315	
	500V	A	315	
	690V	A	250	
Power dissipation per pole max	W			24
Rated operational power AC23A	400V	kW	185	
	690V	kW	200	
Conditional short-circuit current (rms)	kA			100
Specific let through energy I ² t	kA ² s			1.6
Making capacity AC23A 400V	A			3150
Breaking capacity AC23A 400V	A			2600
Mechanical life	cycles			10000
Electrical life AC21A	cycles			1000 (AC23A 400V)
Mechanical features				
Operating position	normal allowable			Vertical plan Any
Fixing				Screw
Terminals	type screw			Bar M10
Tightening torque for terminals	max	Nm	24	
	max	lbin	18	

Bar dimensions max 30x4

Ambient conditions

Operating temperature
min °C -25
max °C 55

Storage temperature
min °C -40
max °C 70

Max altitude m 3000

Resistance & Protection

Frontal IP degree IP20

Pollution degree 3

Dimensions

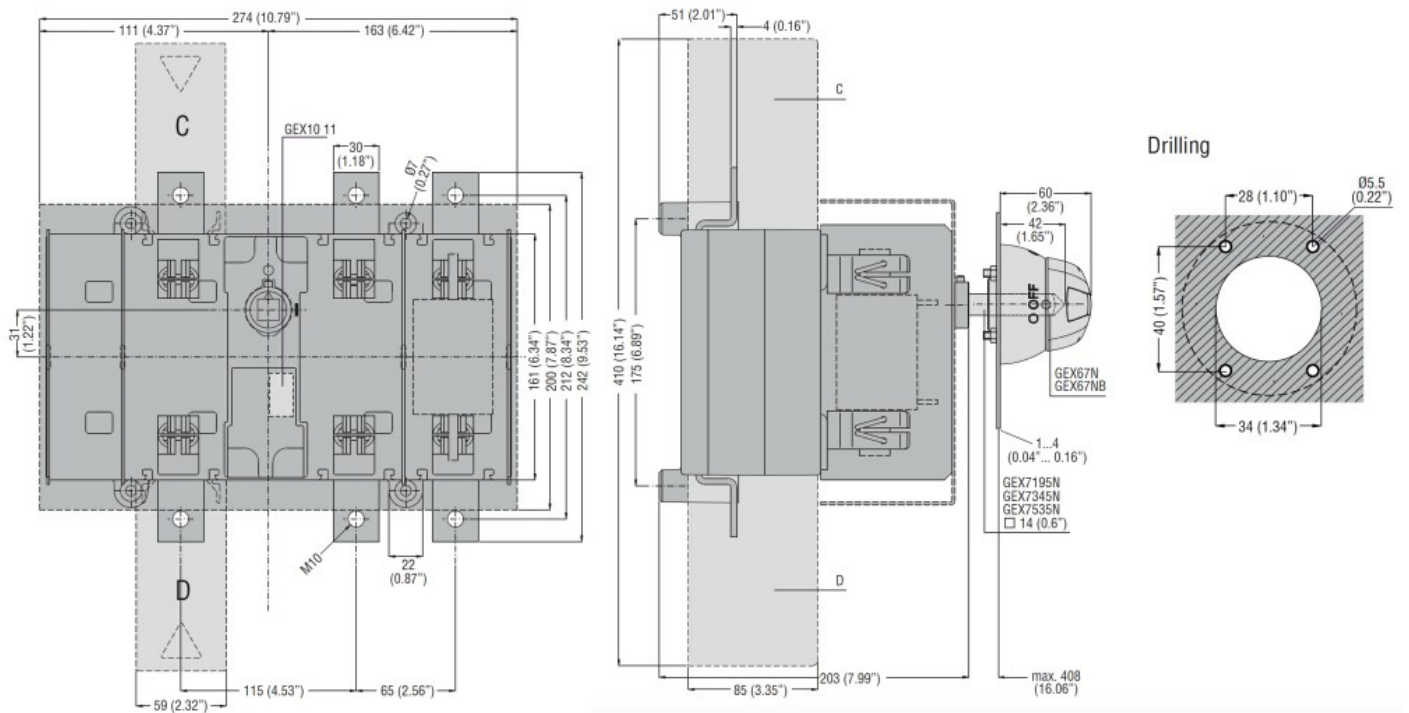

Wiring diagrams

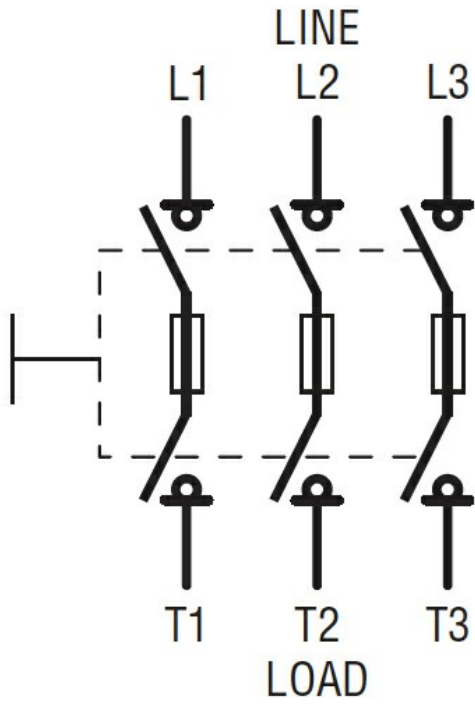

Certifications and compliance

Compliance

IEC/EN 60947-1

IEC/EN 60947-3

Certifications

EAC

ETIM classification

ETIM 8.0

EC000216 -
 Switch
 disconnecter