



Product designation				Switch disconnecter
Product type designation				GE
Number of poles				Nr. 3
Operating voltage type				AC
Contact characteristics				
IEC Conventional free air thermal current I _{th}			A	250
Rated insulation voltage U _i IEC/EN			V	1000
Rated impulse withstand voltage U _{imp}			kV	8
Operating current I _e				
AC21A	400V	A	200	
	500V	A	200	
	690V	A	180	
AC22A	400V	A	200	
	500V	A	200	
	690V	A	160	
AC23A	400V	A	160	
	500V	A	125	
	690V	A	80	
Power dissipation per pole max			W	9
Rated operational power AC23A	400V	kW	90	
	690V	kW	75	
Rated short time current (1s) I _{cw} (rms)			kA	7
Conditional short-circuit current (rms)			kA	100
Short-circuit protection with fuse			Class/A	gG250
Making capacity AC23A 400V			A	1600
Breaking capacity AC23A 400V			A	1280
Mechanical life			cycles	30000
Electrical life AC21A			cycles	1000 (AC23A 400V)
Mechanical features				
Operating position	normal allowable		Vertical plan Any	
Fixing			Screw	
Terminals	type screw		Bar M10	
Tightening torque for terminals	max	Nm	18	
	max	Ibin	10	

Bar dimensions max	26x3		
Ambient conditions			
Operating temperature	min	°C	-25
	max	°C	55
Storage temperature	min	°C	-40
	max	°C	70
Max altitude	m		3000

Resistance & Protection

Frontal IP degree	IP20
-------------------	------

Pollution degree	3
------------------	---

Dimensions

Door coupling version
with handle GAX66 - GAX66 B

Drilling

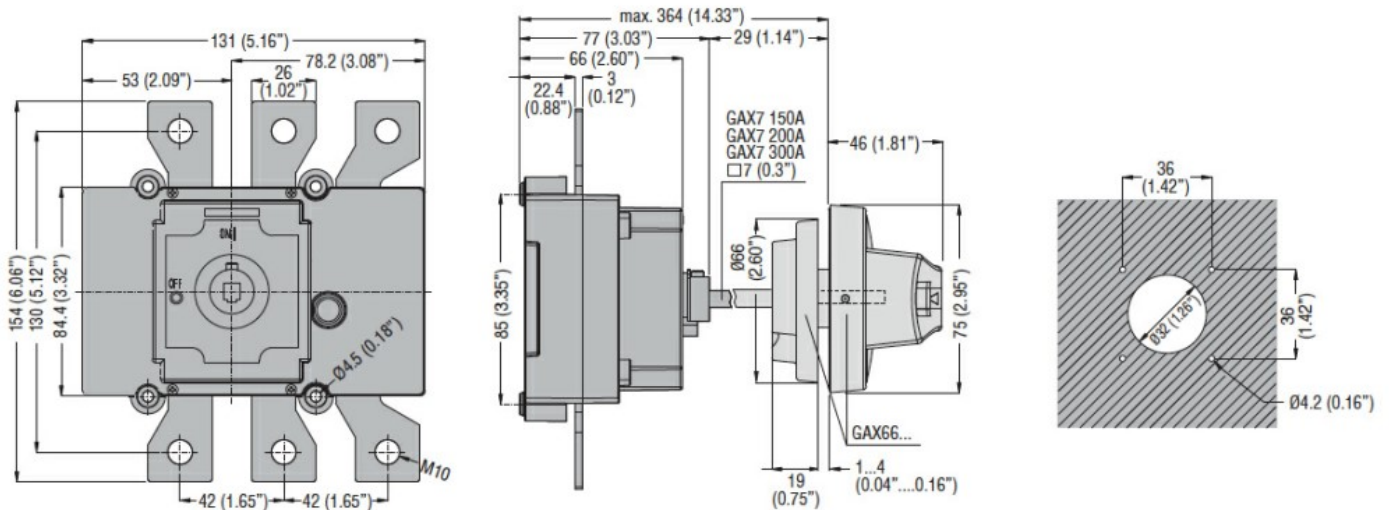

Direct operating version with handle GEX6 5D

With terminal cover and auxiliary contact

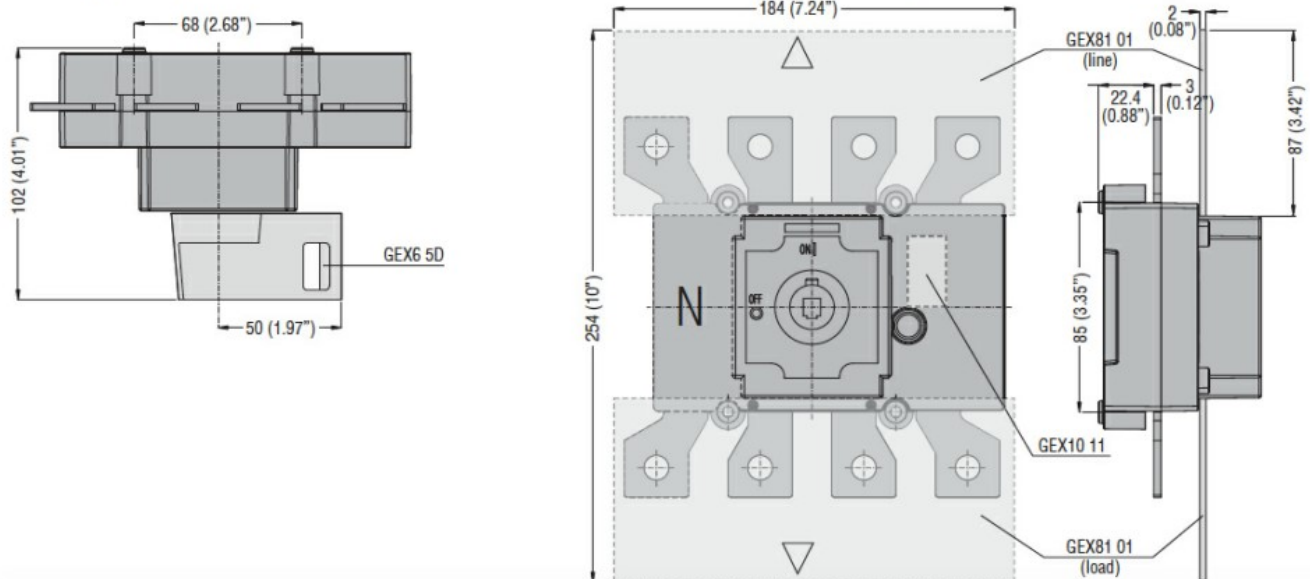

Wiring diagrams

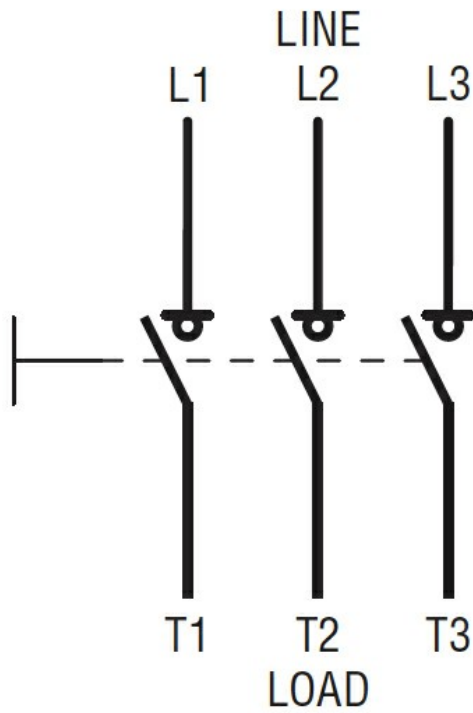

Certifications and compliance

Compliance

IEC/EN 60947-1

IEC/EN 60947-3

Certifications

EAC

ETIM classification

ETIM 8.0

EC000216 -
 Switch
 disconnecter