



Product designation				Changeover Switch
Product type designation				GE
Number of poles	Nr.			3
Operating voltage type				AC
Contact characteristics				
IEC Conventional free air thermal current I _{th}	A	200		
Rated insulation voltage U _i IEC/EN	V	1000		
Rated impulse withstand voltage U _{imp}	kV	8		
Operating current I _e				
AC21A	400V	A	200	
	500V	A	200	
	690V	A	200	
AC22A	400V	A	200	
	500V	A	200	
	690V	A	160	
AC23A	400V	A	160	
	500V	A	125	
Power dissipation per pole max	W		8	
Rated operational power AC23A	400V	kW	100	
	690V	kW	69	
Rated short time current (1s) I _{cw} (rms)	kA		8	
Conditional short-circuit current (rms)	kA		100	
Short-circuit protection with fuse	Class/A	gG200		
Making capacity AC23A 400V	A	3150		
Mechanical life	cycles		10000	
Electrical life AC21A	cycles		1000 (AC23A 400V)	
Mechanical features				
Operating position	normal allowable	Vertical plan Any		
Fixing	Screw			
Terminals	type screw	Bar M10		
Tightening torque for terminals	max	Nm	24	
	max	Ibin	18	
Bar dimensions max	25x3			
Ambient conditions				

Operating temperature

min	°C	-25
max	°C	55

Storage temperature

min	°C	-40
max	°C	70

Max altitude

m	3000
---	------

Resistance & Protection

Frontal IP degree

IP20

Pollution degree

3

Dimensions

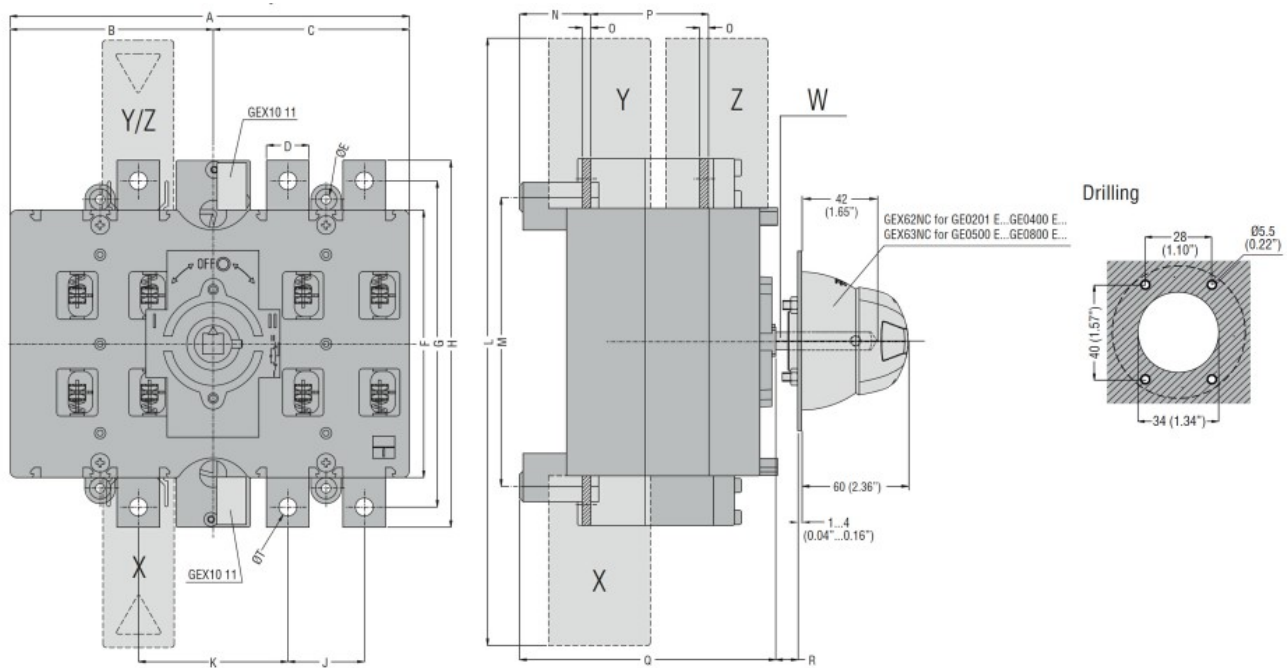

TYPE	A	B	C	D	ØE	F	G	H	J	K	L	M	N	O	P	Q	R Max	S	ØT	U	V	Shaft extension W	Terminal covers (N° of pcs/set)		
																							X (line 1)	Y (line 2)	Z (load)
GE0201 E GE0250 E GE0315 E GE0400 E	235	119.5	115.5	25	5.5	157	192	216	45	88	357	170	42	3	67	151	437	143	M10	133	142	GEX7227N GEX7375N GEX7536N □ 10 (0.6")	GEX82 12 (3)	GEX82 11 (3)	GEX83 12 (3)
GE0201 ET4 GE0250 ET4 GE0315 ET4 GE0400 ET4	(9.25")	(4.70")	(4.55")	(0.98")	(0.22")	(6.18")	(7.56")	(8.50")	(1.77")	(3.46")	(14.05")	(6.69")	(1.65")	(0.12)	(2.64")	(5.94")	(17.2")	(5.63")		(5.24")	(5.59")		GEX82 13 (4)	GEX82 13 (4)	GEX83 12 (4)
GE0500 E GE0630 E GE0800 E	321	162	159	40	7	232	282	312	65	121	482	247	46	5	87	180	417	176	M12	186	171	GEX7195N GEX7345N GEX7535N □ 10 (0.6")	GEX82 22 (3)	GEX82 21 (3)	GEX83 21 (3)
GE0500 ET4 GE0630 ET4 GE0800 ET4	(12.63")	(6.38")	(6.26")	(1.57")	(0.27")	(9.13")	(11.10")	(12.28")	(2.56")	(4.73")	(18.98")	(9.72")	(1.81")	(0.20")	(3.42")	(7.09")	(16.42")	(6.93")		(7.32")	(6.73")		GEX82 23 (4)	GEX82 23 (4)	GEX83 22 (4)

Wiring diagrams

GE0201 E - GE1600 E

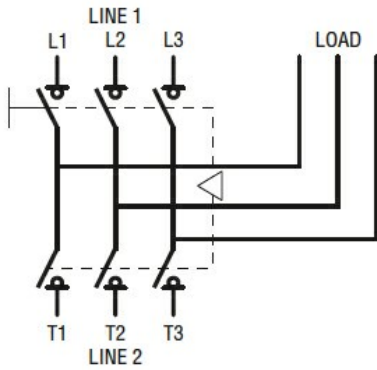

Certifications and compliance

Compliance

IEC/EN 60947-1

IEC/EN 60947-3

Certifications

EAC

ETIM classification

ETIM 8.0

EC000216 -
 Switch
 disconnecter