



Product designation				Changeover Switch
Product type designation				GE
Number of poles	Nr.			4
Operating voltage type				AC
Contact characteristics				
IEC Conventional free air thermal current I _{th}	A			200
Rated insulation voltage U _i IEC/EN	V			1000
Rated impulse withstand voltage U _{imp}	kV			8
Operating current I _e				
AC21A	400V	A	200	
	500V	A	200	
	690V	A	200	
AC22A	400V	A	200	
	500V	A	200	
	690V	A	160	
AC23A	400V	A	160	
	500V	A	125	
Power dissipation per pole max	W			6
Rated operational power AC23A	400V	kW	89	
	690V	kW	76	
Rated short time current (1s) I _{cw} (rms)	kA			7
Conditional short-circuit current (rms)	kA			100
Short-circuit protection with fuse	Class/A			gG200
Making capacity AC23A 400V	A			1600
Mechanical life	cycles			30000
Electrical life AC21A	cycles			1000 (AC23A 400V)
Mechanical features				
Operating position	normal allowable			Vertical plan Any
Fixing				Screw
Terminals	type screw			Bar M10
Tightening torque for terminals	max	Nm	24	
	max	Ibin	18	
Bar dimensions max				26x3
Ambient conditions				

Operating temperature

min	°C	-25
max	°C	55

Storage temperature

min	°C	-40
max	°C	70

Max altitude

m	3000
---	------

Resistance & Protection

Frontal IP degree

IP20

Pollution degree

3

Dimensions

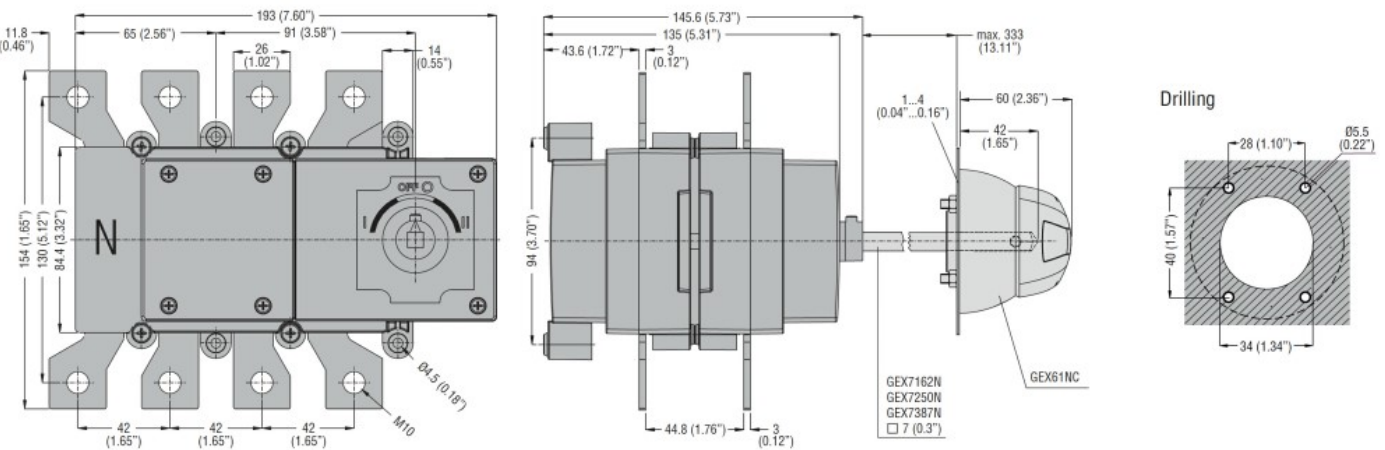

Wiring diagrams

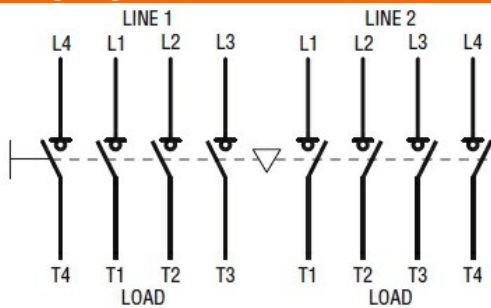

Certifications and compliance

Compliance

IEC/EN 60947-1
IEC/EN 60947-3

Certifications

EAC

ETIM classification

ETIM 8.0

EC000216 -
Switch
disconnecter