



Product designation				Switch disconnecter with fuse
Product type designation				GE
Type of fuse				BS
Number of poles	Nr.			3
Operating voltage type				AC
Contact characteristics				
IEC Conventional free air thermal current I _{th}	A			160
Rated insulation voltage U _i IEC/EN	V			800
Rated impulse withstand voltage U _{imp}	kV			8
Operating current I _e				
AC21A	400V	A	160	
	500V	A	160	
	690V	A	160	
AC22A	400V	A	160	
	500V	A	160	
	690V	A	125	
AC23A	400V	A	160	
	500V	A	125	
	690V	A	100	
Power dissipation per pole max	W			12
Rated operational power AC23A	400V	kW	90	
	690V	kW	90	
Conditional short-circuit current (rms)	kA			100
Specific let through energy I ² t	kA ² s			0.19
Making capacity AC23A 400V	A			1600
Breaking capacity AC23A 400V	A			1280
Mechanical life	cycles			10000
Electrical life AC21A	cycles			1000 (AC23A 400V)
Mechanical features				
Operating position	normal allowable			Vertical plan Any
Fixing				Screw
Terminals	type screw			Bar M8
Tightening torque for terminals	max	Nm	13	
	max	lbin	10	

Bar dimensions max 20x3

Ambient conditions

Operating temperature
min °C -25
max °C 55

Storage temperature
min °C -40
max °C 70

Max altitude m 3000

Resistance & Protection

Frontal IP degree IP20

Pollution degree 3

Dimensions

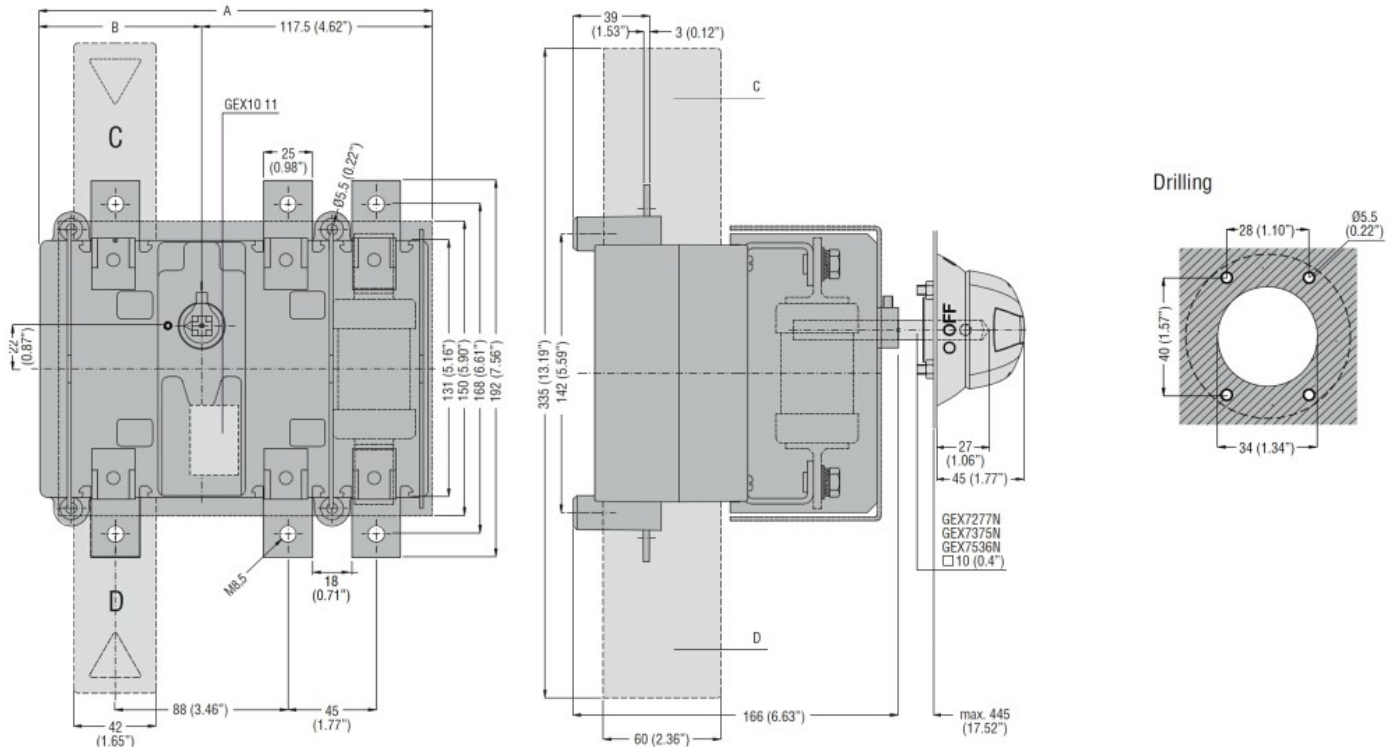

Wiring diagrams

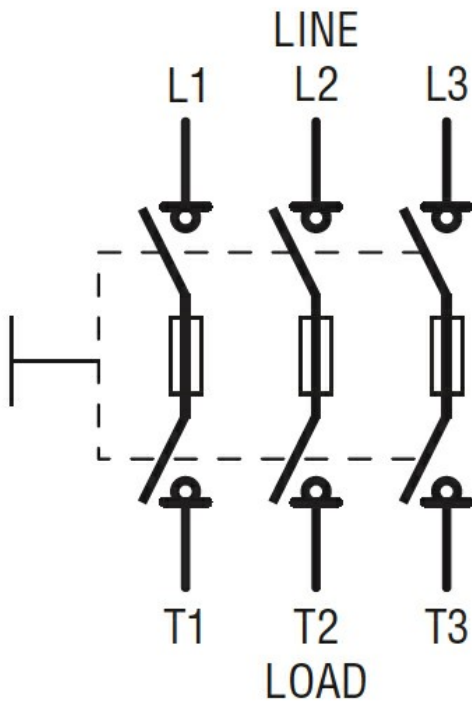

Certifications and compliance

Compliance

IEC/EN 60947-1

IEC/EN 60947-3

Certifications

EAC

ETIM classification

ETIM 8.0

EC000216 -
 Switch
 disconnecter