



Product designation				Enclosed switch disconnecter
Product type designation				GAZM
Number of poles	Nr.			4
Operating voltage type				AC
<b>Contact characteristics</b>				
IEC Conventional free air thermal current I <sub>th</sub>	A			160
Rated insulation voltage U <sub>i</sub> IEC/EN	V			1000
Rated impulse withstand voltage U <sub>imp</sub>	kV			8
Operating current I <sub>e</sub>				
AC21A	400V	A	160	
	500V	A	160	
	690V	A	160	
AC22A	400V	A	160	
	500V	A	125	
	690V	A	125	
AC23A	400V	A	125	
	500V	A	100	
	690V	A	47	
Power dissipation per pole max	W			12
Rated operational power AC23A	400V	kW	55	
	690V	kW	45	
Conditional short-circuit current (rms)	kA			50
Short-circuit protection with fuse	Class/A			gG160
Making capacity AC23A 400V	A			1250
Breaking capacity AC23A 400V	A			1000
Mechanical life	cycles			30000
Electrical life AC21A	cycles			1500
<b>Mechanical features</b>				
Operating position	normal allowable			Vertical plan Any
Terminals	type			Pillar
	width	mm	12.4	
	height	mm	10.4	
	screw			M8
	tool			Metric Allen key 4
Tightening torque for terminals	min	Nm	5	
	max	Nm	6	

	min	lbin	45
	max	lbin	54

Conductor section

IEC min	mm <sup>2</sup>	4
IEC max	mm <sup>2</sup>	70
AWG/kcmil min		12
AWG/kcmil max		1

Ambient conditions

Operating temperature

min	°C	-25
max	°C	+55

Storage temperature

min	°C	-40
max	°C	+70

Max altitude

m	3000
---	------

Resistance & Protection

Frontal IP degree

IP65

Pollution degree

3

Dimensions

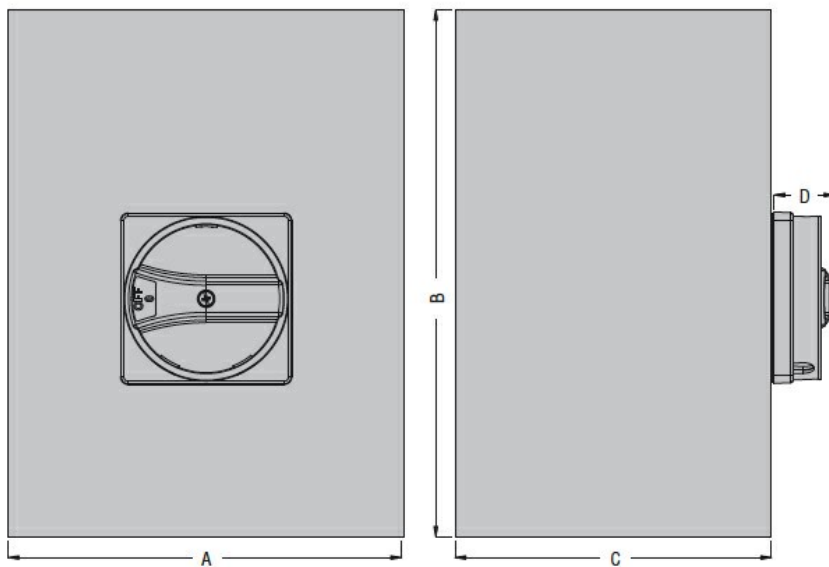

Type	A	B	C	D
GAZM125...GAZM160...	200 (7.87")	300 (11.81")	120 (4.72")	23 (0.90")

Wiring diagrams

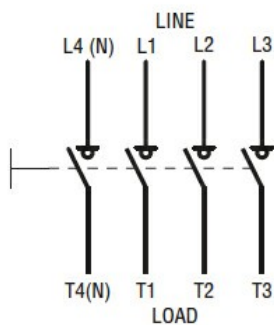

Certifications and compliance

Compliance

IEC/EN 60947-1  
IEC/EN 60947-3

---

ETIM classification

ETIM 8.0

EC000216 -  
Switch  
disconnector