



Product designation				Enclosed switch disconnecter
Product type designation				GAZM
Number of poles		Nr.	4	
Operating voltage type				AC
Contact characteristics				
IEC Conventional free air thermal current I _{th}		A	32	
Rated insulation voltage U _i IEC/EN		V	1000	
Rated impulse withstand voltage U _{imp}		kV	8	
Operating current I _e				
	AC21A			
		400V	A	32
		500V	A	32
		690V	A	32
	AC22A			
		400V	A	32
		500V	A	32
		690V	A	32
	AC23A			
		400V	A	32
		500V	A	25
		690V	A	25
Power dissipation per pole max			W	0.6
Rated operational power AC23A				
		400V	kW	15
		690V	kW	22
Conditional short-circuit current (rms)			kA	10
Short-circuit protection with fuse			Class/A	gG32
Making capacity AC23A 400V			A	400
Breaking capacity AC23A 400V			A	320
Mechanical life			cycles	100000
Electrical life AC21A			cycles	100000
Mechanical features				
Operating position		normal allowable	Vertical plan Any	
Terminals		type	Pillar	
		width	mm	5.6
		height	mm	6.5
		screw	M4	
		tool	Phillips 2	
Tightening torque for terminals				
		min	Nm	1.8
		max	Nm	2

	min	lbin	16
	max	lbin	18

Conductor section

IEC min	mm ²	0.75
IEC max	mm ²	16
AWG/kcmil min		18
AWG/kcmil max		6

Ambient conditions

Operating temperature

min	°C	-25
max	°C	+55

Storage temperature

min	°C	-40
max	°C	+70

Max altitude

m	3000
---	------

Resistance & Protection

Frontal IP degree

IP65

IP degree of protection

IP65

Pollution degree

3

Dimensions

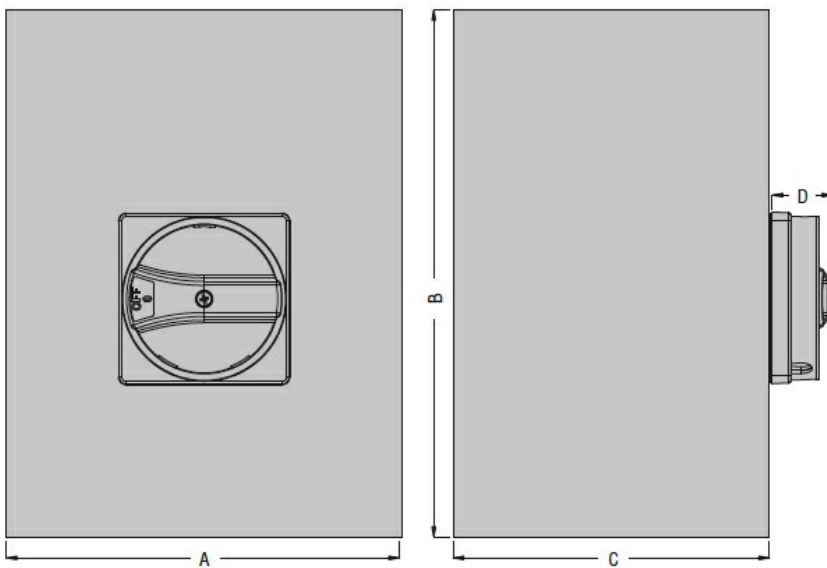

Type	A	B	C	D
GAZM016...GAZM100...	150 (5.90")	200 (7.87")	120 (4.72")	23 (0.90")

Wiring diagrams

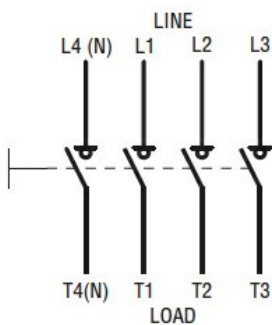

Certifications and compliance

Compliance

IEC/EN 60947-1

IEC/EN 60947-3

ETIM classification

ETIM 8.0

EC000216 -
Switch
disconnector