

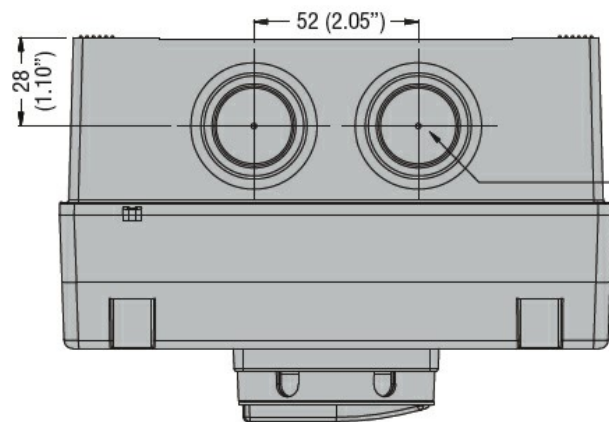

Product designation				Enclosed switch disconnecter	
Product type designation				GAZ	
Number of poles	Nr.			4	
Operating voltage type				AC	
Contact characteristics					
IEC Conventional free air thermal current I _{th}	A			63	
Rated insulation voltage U _i IEC/EN	V			1000	
Rated impulse withstand voltage U _{imp}	kV			8	
Operating current I _e					
AC21A		400V	A	63	
		500V	A	63	
		690V	A	63	
AC22A		400V	A	63	
		500V	A	45	
		690V	A	45	
AC23A		400V	A	45	
		500V	A	25	
		690V	A	25	
Power dissipation per pole max	W			2.9	
Rated operational power AC23A		400V	kW	22	
		690V	kW	22	
Conditional short-circuit current (rms)	kA			10	
Short-circuit protection with fuse	Class/A			gG63	
Making capacity AC23A 400V	A			450	
Breaking capacity AC23A 400V	A			360	
Mechanical life	cycles			100000	
Electrical life AC21A	cycles			15000	
Mechanical features					
Operating position	normal allowable			Vertical plan Any	
Terminals	type			Pillar	
	width	mm			5.6
	height	mm			6.5
	screw			M4	
	tool			Phillips 2	
Tightening torque for terminals	min	Nm			1.8
	max	Nm			2

	min	lbin	16
	max	lbin	18
<hr/>			
Conductor section			
	IEC min	mm ²	0.75
	IEC max	mm ²	16
	AWG/kcmil min		18
	AWG/kcmil max		6
<hr/>			
Ambient conditions			
Operating temperature			
	min	°C	-25
	max	°C	+55
<hr/>			
Storage temperature			
	min	°C	-40
	max	°C	+70
<hr/>			
Max altitude		m	3000
<hr/>			
Resistance & Protection			
Frontal IP degree			IP65
IP degree of protection			IP65
Pollution degree			3
<hr/>			
Dimensions			

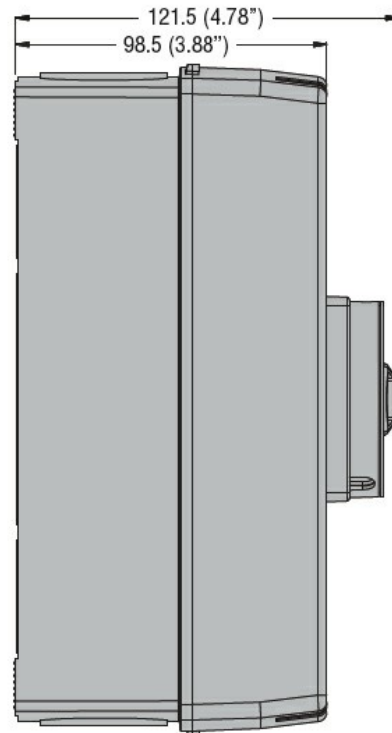
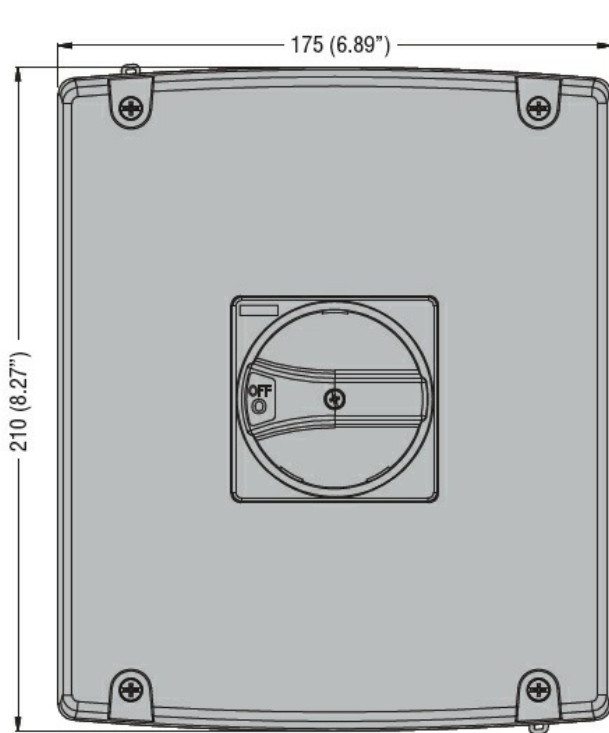

Drilling for surface fixing

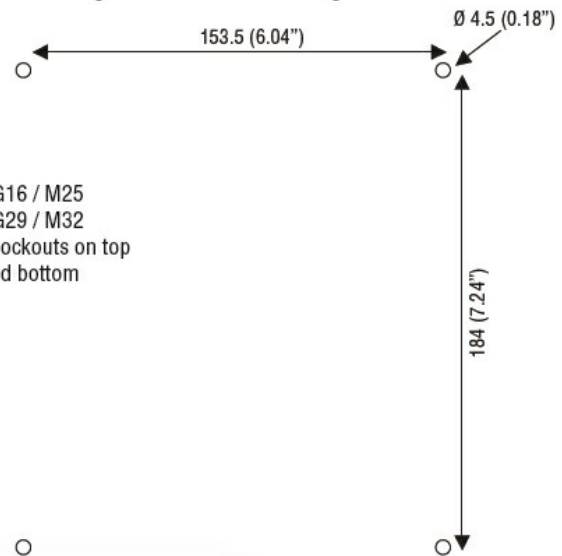

PG16 / M25
PG29 / M32
knockouts on top
and bottom

Wiring diagrams

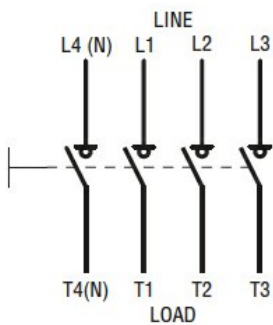

Certifications and compliance

Compliance

IEC/EN 60947-1

IEC/EN 60947-3

Certifications

EAC

ETIM classification

ETIM 8.0

EC000216 -
Switch
disconnector