

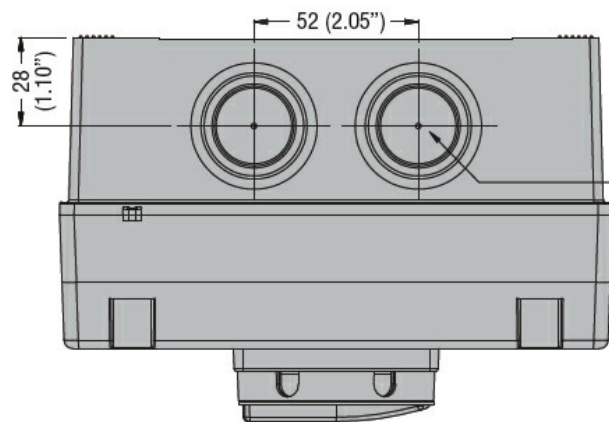

Product designation				Enclosed switch disconnecter
Product type designation				GAZ
Number of poles		Nr.		3
Operating voltage type				AC
Contact characteristics				
IEC Conventional free air thermal current I _{th}		A		63
Rated insulation voltage U _i IEC/EN		V		1000
Rated impulse withstand voltage U _{imp}		kV		8
Operating current I _e				
	AC21A			
		400V	A	63
		500V	A	63
		690V	A	63
	AC22A			
		400V	A	63
		500V	A	45
		690V	A	45
	AC23A			
		400V	A	45
		500V	A	25
		690V	A	25
Power dissipation per pole max			W	2.9
Rated operational power AC23A				
		400V	kW	22
		690V	kW	22
Conditional short-circuit current (rms)			kA	10
Short-circuit protection with fuse			Class/A	gG63
Making capacity AC23A 400V			A	450
Breaking capacity AC23A 400V			A	360
Mechanical life			cycles	100000
Electrical life AC21A			cycles	15000
Mechanical features				
Operating position		normal allowable		Vertical plan Any
Terminals				
		type		Pillar
		width	mm	5.6
		height	mm	6.5
		screw		M4
		tool		Phillips 2
Tightening torque for terminals				
		min	Nm	1.8
		max	Nm	2

	min	lbin	16
	max	lbin	18
<hr/>			
Conductor section			
	IEC min	mm ²	0.75
	IEC max	mm ²	16
	AWG/kcmil min		18
	AWG/kcmil max		6
<hr/>			
Ambient conditions			
Operating temperature			
	min	°C	-25
	max	°C	+55
<hr/>			
Storage temperature			
	min	°C	-40
	max	°C	+70
<hr/>			
Max altitude		m	3000
<hr/>			
Resistance & Protection			
Frontal IP degree			IP65
IP degree of protection			IP65
Pollution degree			3
<hr/>			
Dimensions			

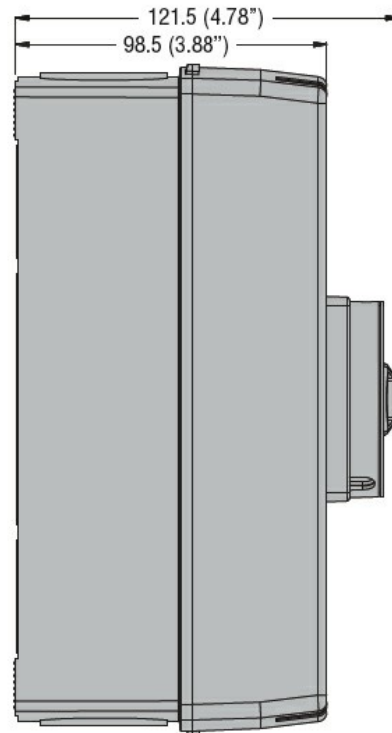
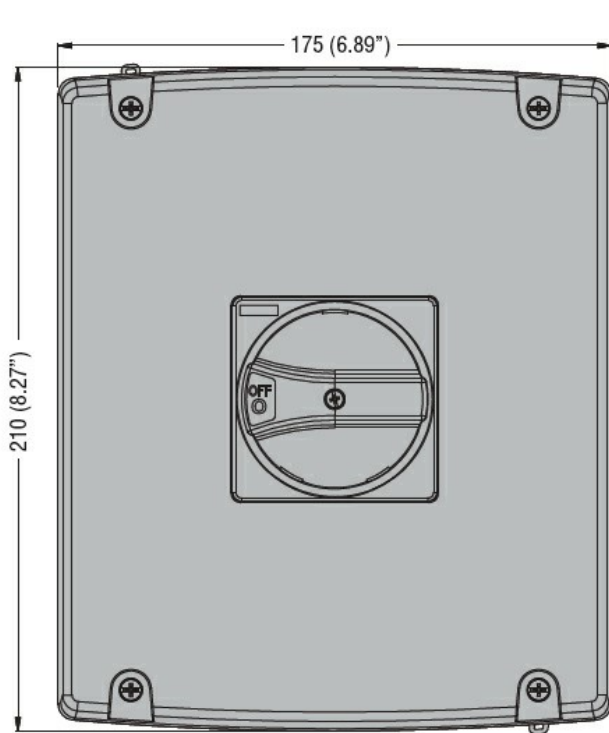

Drilling for surface fixing

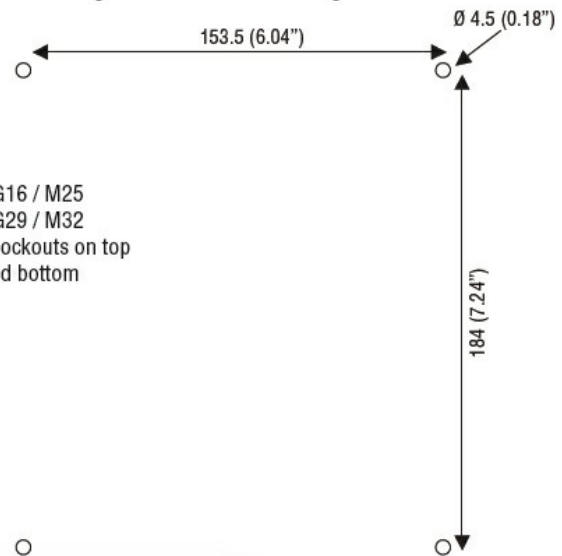

PG16 / M25
PG29 / M32
knockouts on top
and bottom

Wiring diagrams

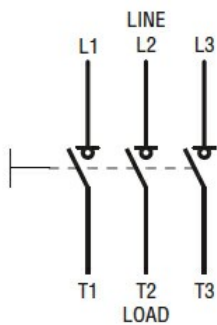

Certifications and compliance

Compliance

IEC/EN 60947-1
IEC/EN 60947-3

Certifications

EAC

ETIM classification

ETIM 8.0

EC000216 -
Switch
disconnecter