

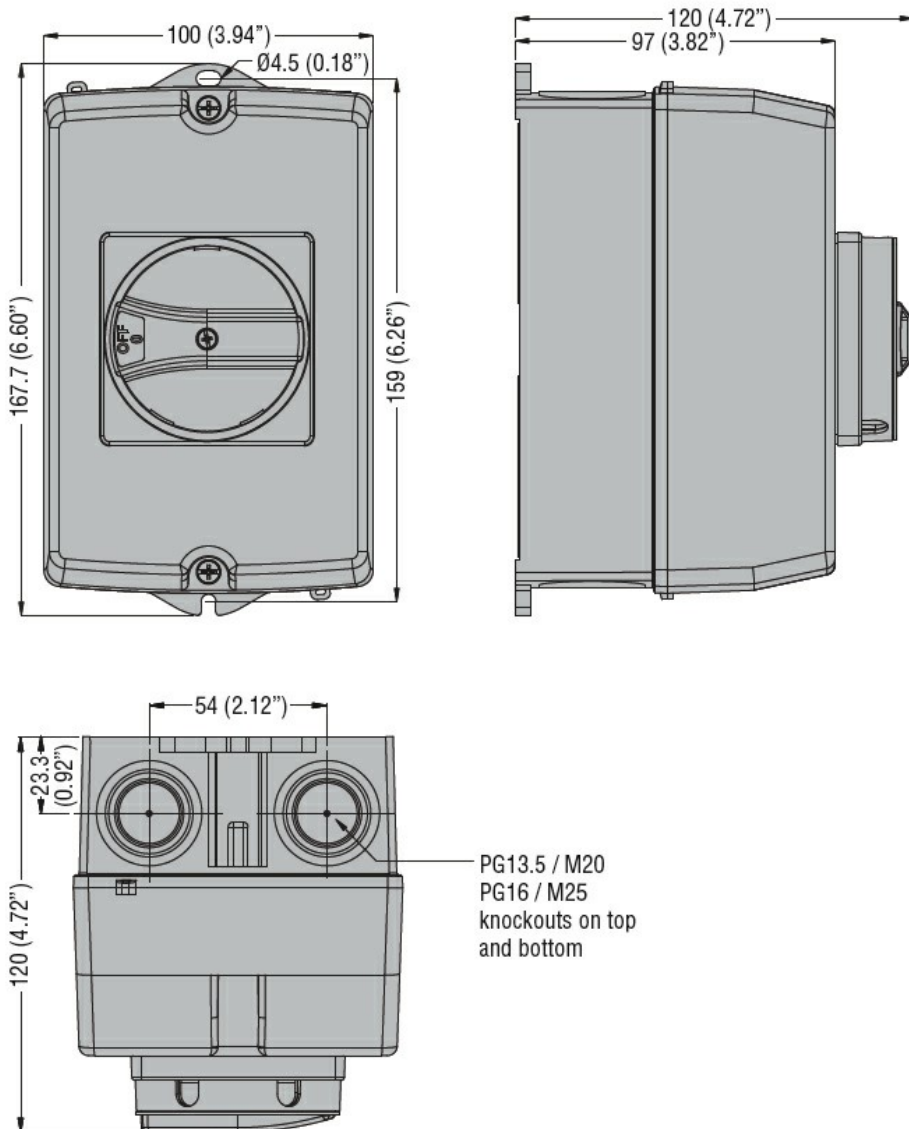

Product designation				Enclosed switch disconnecter
Product type designation				GAZ
Number of poles	Nr.			4
Operating voltage type				AC
Contact characteristics				
IEC Conventional free air thermal current I _{th}	A			40
Rated insulation voltage U _i IEC/EN	V			1000
Rated impulse withstand voltage U _{imp}	kV			8
Operating current I _e				
AC21A				
	400V	A	40	
	500V	A	40	
	690V	A	40	
AC22A				
	400V	A	40	
	500V	A	40	
	690V	A	40	
AC23A				
	400V	A	40	
	500V	A	25	
	690V	A	25	
Power dissipation per pole max	W			1
Rated operational power AC23A				
	400V	kW	18.5	
	690V	kW	22	
Conditional short-circuit current (rms)	kA			10
Short-circuit protection with fuse	Class/A			gG40
Making capacity AC23A 400V	A			400
Breaking capacity AC23A 400V	A			320
Mechanical life	cycles			100000
Electrical life AC21A	cycles			100000
Mechanical features				
Operating position	normal allowable			Vertical plan Any
Terminals	type			Pillar
	width	mm	5.6	
	height	mm	6.5	
	screw			M4
	tool			Phillips 2
Tightening torque for terminals	min	Nm	1.8	
	max	Nm	2	

	min	lbin	16
	max	lbin	18
Conductor section			
	IEC min	mm ²	0.75
	IEC max	mm ²	16
	AWG/kcmil min		18
	AWG/kcmil max		6
Ambient conditions			
Operating temperature			
	min	°C	-25
	max	°C	+55
Storage temperature			
	min	°C	-40
	max	°C	+70
Max altitude			
		m	3000
Resistance & Protection			
Frontal IP degree			IP65
IP degree of protection			IP65
Pollution degree			3
Dimensions			



Wiring diagrams

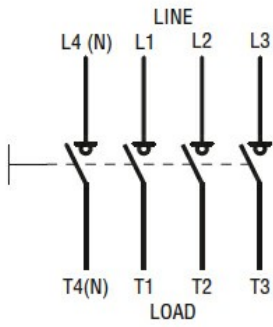

Certifications and compliance

Compliance

IEC/EN 60947-1
IEC/EN 60947-3

Certifications

EAC

ETIM classification

ETIM 8.0

EC000216 -
Switch
disconnector