

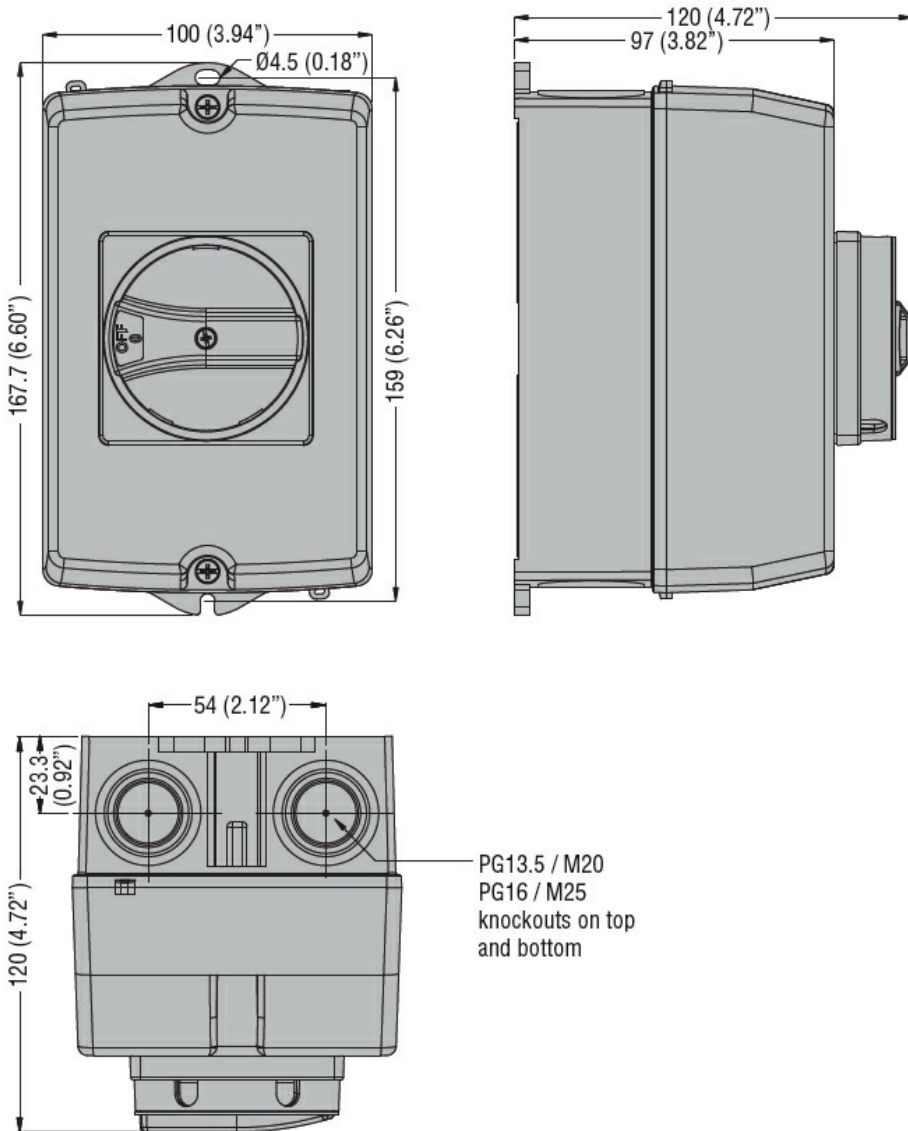

Product designation				Enclosed switch disconnecter
Product type designation				GAZ
Number of poles		Nr.	4	
Operating voltage type			AC	
<b>Contact characteristics</b>				
IEC Conventional free air thermal current I <sub>th</sub>		A	32	
Rated insulation voltage U <sub>i</sub> IEC/EN		V	1000	
Rated impulse withstand voltage U <sub>imp</sub>		kV	8	
Operating current I <sub>e</sub>				
	AC21A			
		400V	A	32
		500V	A	32
		690V	A	32
	AC22A			
		400V	A	32
		500V	A	32
		690V	A	32
	AC23A			
		400V	A	32
		500V	A	25
		690V	A	25
Power dissipation per pole max			W	0.6
Rated operational power AC23A				
		400V	kW	15
		690V	kW	22
Conditional short-circuit current (rms)			kA	10
Short-circuit protection with fuse			Class/A	gG32
Making capacity AC23A 400V			A	320
Breaking capacity AC23A 400V			A	256
Mechanical life			cycles	100000
Electrical life AC21A			cycles	100000
<b>Mechanical features</b>				
Operating position		normal allowable	Vertical plan Any	
Terminals		type	Pillar	
		width	mm	5.6
		height	mm	6.5
		screw	M4	
		tool	Phillips 2	
Tightening torque for terminals				
		min	Nm	1.8
		max	Nm	2

	min	lbin	16
	max	lbin	18
<hr/>			
Conductor section			
	IEC min	mm <sup>2</sup>	0.75
	IEC max	mm <sup>2</sup>	16
	AWG/kcmil min		18
	AWG/kcmil max		6
<hr/>			
<b>UL technical data</b>			
General purpose current rating		A	32
Operating voltage max		V	600
<hr/>			
Horsepower/FLA current single phase motor			
	120V	HP	2/24
	240V	HP	5/28
<hr/>			
Horsepower/FLA current three phase motor			
	200-208V	HP	10/32.2
	240V	HP	10/28
	480V	HP	20/27
	600V	HP	20/22
<hr/>			
Short circuit rating		kA rms	5
Short circuit rating with fuse		Class/A	RK5/35
<hr/>			
<b>Ambient conditions</b>			
Operating temperature			
	min	°C	-25
	max	°C	+55
<hr/>			
Storage temperature			
	min	°C	-40
	max	°C	+70
<hr/>			
Max altitude		m	3000
<hr/>			
<b>Resistance &amp; Protection</b>			
Frontal IP degree			IP65
UL degree of protection			UL/CSA Type 4/4X
IP degree of protection			IP65
Pollution degree			3
<hr/>			
<b>Dimensions</b>			



### Wiring diagrams

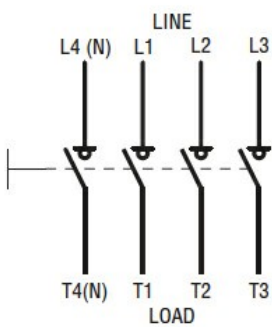

### Certifications and compliance

#### Compliance

IEC/EN 60947-1  
IEC/EN 60947-3

#### Certifications

cULus  
EAC

### ETIM classification

ETIM 8.0

EC000216 -  
Switch  
disconnector