



Product designation				Enclosed changeover switch
Product type designation				GAZ
Number of poles	Nr.			4
Operating voltage type				AC
Contact characteristics				
IEC Conventional free air thermal current I _{th}	A			25
Rated insulation voltage U _i IEC/EN	V			1000
Rated impulse withstand voltage U _{imp}	kV			8
Operating current I _e				
AC21A	400V	A	25	
	500V	A	25	
	690V	A	25	
AC22A	400V	A	25	
	500V	A	25	
	690V	A	25	
AC23A	400V	A	25	
	500V	A	25	
	690V	A	25	
Power dissipation per pole max	W			0.4
Rated operational power AC23A	400V	kW	11	
	690V	kW	22	
Conditional short-circuit current (rms)	kA			10
Short-circuit protection with fuse	Class/A			gG25
Making capacity AC23A 400V	A			250
Breaking capacity AC23A 400V	A			200
Mechanical life	cycles			100000
Electrical life AC21A	cycles			100000
Mechanical features				
Operating position	normal allowable			Vertical plan Any
Terminals	type			Pillar
	width	mm	5.6	
	height	mm	6.5	
	screw			M4
	tool			Phillips 2
Tightening torque for terminals	min	Nm	1.8	

max	Nm	2
min	lbin	16
max	lbin	18

Conductor section

IEC min	mm ²	0.75
IEC max	mm ²	16
AWG/kcmil min		18
AWG/kcmil max		6

Ambient conditions

Operating temperature

min	°C	-25
max	°C	+55

Storage temperature

min	°C	-40
max	°C	+70

Max altitude

m	3000
---	------

Resistance & Protection

Frontal IP degree

IP65

IP degree of protection

IP65

Pollution degree

3

Dimensions

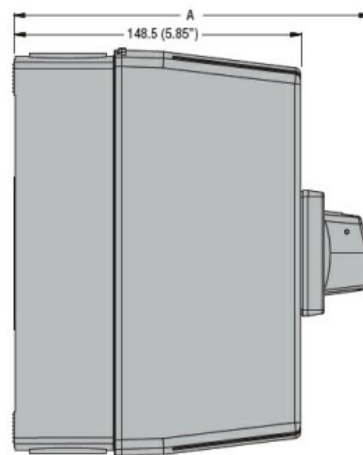
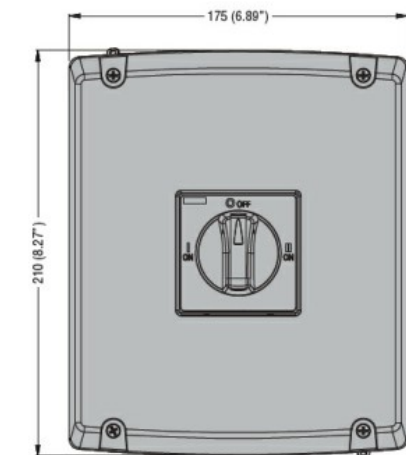

Drilling

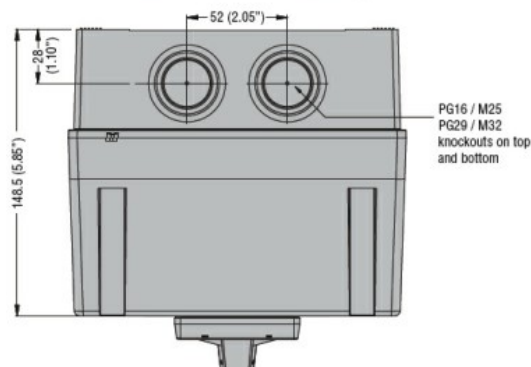
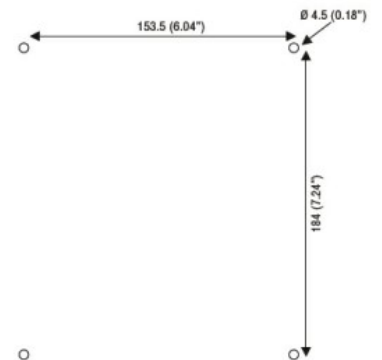

Type	A
GAZ032 D...	171.5 (6.75")
GAZ040 D...	171.5 (6.75")
GAZ025 ET...	183.5 (7.22")
GAZ063 SAET...	183.5 (7.22")

Wiring diagrams

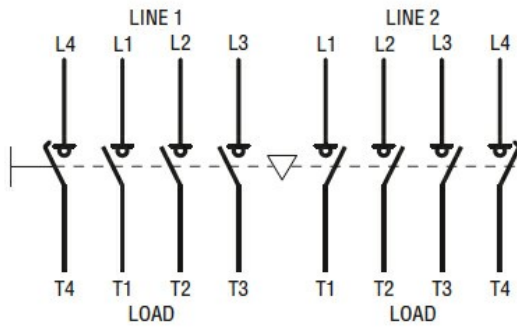

Certifications and compliance

Compliance

IEC/EN 60947-1
IEC/EN 60947-3
UL 508 e CSA C22.2 n°14

Certifications

cCSAus
EAC

ETIM classification

ETIM 8.0

EC000216 -
Switch
disconnector