

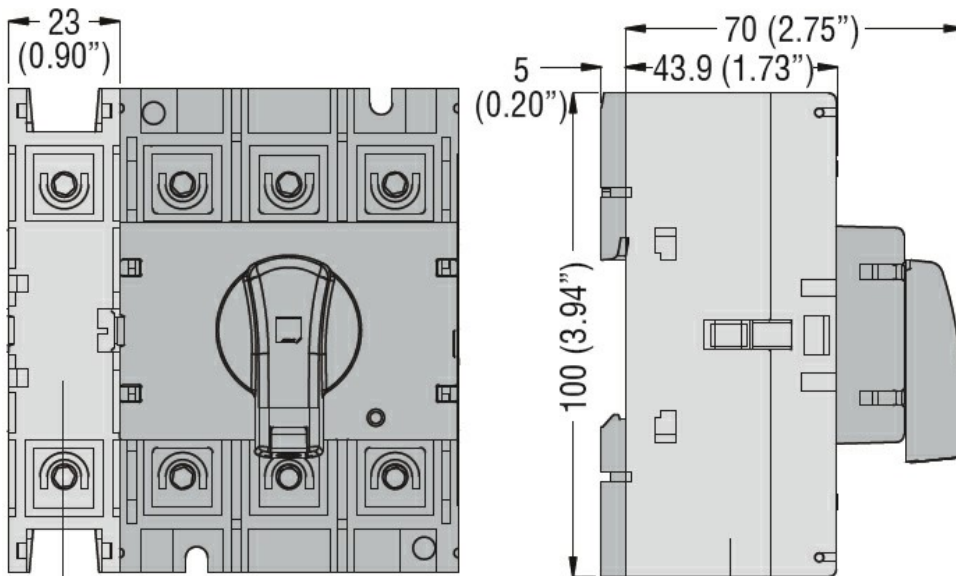

Number of poles	Nr.	1
Operating voltage type		AC
Contact characteristics		
IEC Conventional free air thermal current I _{th}	A	63
Mechanical features		
Tightening torque for terminals	min	Nm 5
	max	Nm 6
	min	lbin 45
	max	lbin 54

Dimensions



GAX41 125A, GAX42 063A... GAX42 160A,
GAX32 A, GAX34 A

Wiring diagrams

Fourth pole add on
GAX42... **GAX41...**

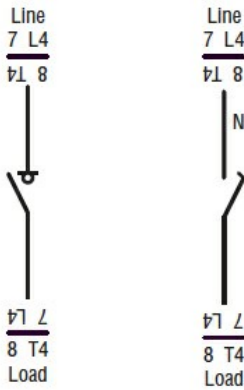

Certifications and compliance

Compliance

CSA C22.2

IEC/EN 60947-1

IEC/EN 60947-3

UL508

UL98

Certifications

CCC

CSA C22.2 n°4

cULus according to UL98

EAC

ETIM classification

ETIM 8.0

EC002498 -
Accessories/spare
parts for low-
voltage switch
technology