



Product designation

Surge Protection
Device (SPD)

Product type designation

SG2DG

Operating voltage type

DC

Application

DC Power lines

Number of DIN modules

3

SPD according to EN50539-11

Yes

Electrical features

Rated operational voltage DC	VDC	1500
Maximum continuous voltage Ucpv	V	1500
IEC Maximum discharge current I _{max} 8/20 (L-N/N-PE)	kA	30
IEC Rated discharge current (IEC) I _n 8/20 (L-N/N-PE)	kA	20
IEC Voltage protection level U _p (L-N/N-PE)	kV	<5.0
Tripping time t _a (L-N/N-PE)	ns	<25
Thermal insulation protection		YES
Backup protection fuse (IEC) with I _{sc} >100A	Class/A	Not needed
Maximum short circuit current I _{scpv}	kA	11
Status indicator - operating / end of life		Frontal indication

Ambient conditions

Operating temperature

min	°C	-40
max	°C	+85

Max altitude

m 2000

Mechanical features

Fixing

Din rail

Conductor section Flexible max (IEC)

mm² 25

Conductor section Rigid max (IEC)

mm² 35

Weight

g 444

Relay output for remote status indication

Rated current at

48V DC A 0.5

Dimensions

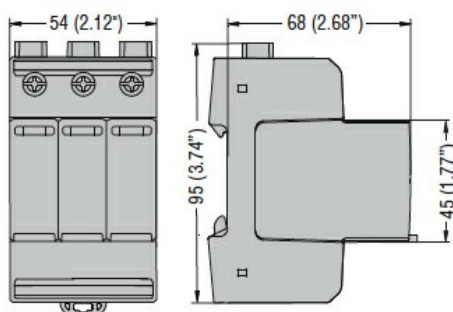

Wiring diagrams

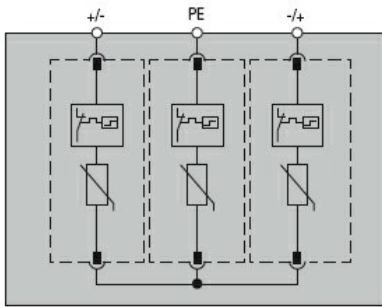

Certifications and compliance

Compliance

IEC/EN/BS 50539-11

Certificates

EAC

ETIM classification

ETIM 8.0

EC000941 -
Surge protection
device for power
supply systems