



Product designation	Surge Protection Device (SPD)
Product type designation	SG2
Operating voltage type	AC
Application	AC Power lines
Number of poles	4P
Number of DIN modules	4
Relay output	Yes
SPD according to IEC/EN 61643-11	YES

Electrical features

IEC Maximum continuous voltage U_c	V	300
IEC Maximum discharge current I_{max} 8/20 (L-N/N-PE)	kA	50
IEC Rated discharge current (IEC) I_n 8/20 (L-N/N-PE)	kA	20
IEC Voltage protection level U_p (L-N/N-PE)	kV	<1.5
IEC Follow current I_f (N-PE) rms	A	No
Tripping time t_a (L-N/N-PE)	ns	<25
Thermal insulation protection		YES
IEC Backup protection fuse with supply fuse >315A (L-N/N-PE)	Class/A	315A / 250A Gg
IEC Maximum short circuit current at 50Hz	kA	25 / 50
Status indicator - operating / end of life		Frontal indication/Aux contact

Ambient conditions

Operating temperature	min	°C	-40
	max	°C	+85
Max altitude		m	2000

Mechanical features

Fixing		Din rail
Conductor section Flexible max (IEC)	mm ²	25
Conductor section Rigid max (IEC)	mm ²	35
Weight	g	505

Relay output for remote status indication

Rated current at	125V AC	A	1
	250V AC	A	1
	12V DC	A	0.5
	24V DC	A	0.5
	48V DC	A	0.5

Dimensions

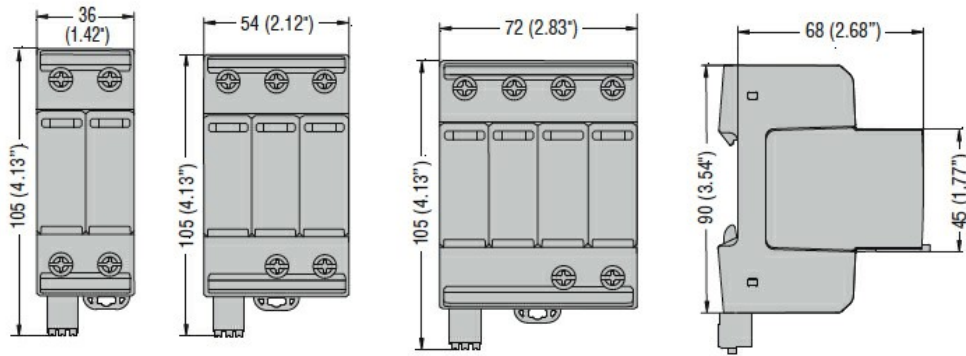

Wiring diagrams

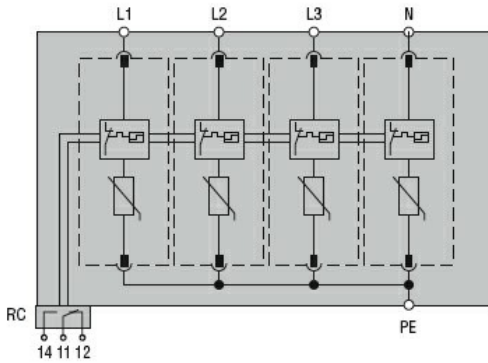

Certifications and compliance

Compliance

IEC/EN 61643-11

Certificates

EAC

ETIM classification

ETIM 8.0

EC000941 -
Surge protection
device for power
supply systems