



Product designation	Solid state relay		
Product type designation	HS1B		
Type	single-phase		
<b>Input characteristics</b>			
Control voltage	18...280VAC/DC		
Operating voltage limits	Operating voltage pick-up	V	18
	Operating voltage drop-out	V	8
Input current at min...max voltage		mA	4.5...6
<b>Operating times</b>			
Switching-on	Half cycle max		
Switching-off	Half cycle max		
<b>Output characteristics</b>			
Switching mode	Zero crossing		
Rated operating voltage	VAC	24...600	
Blocking voltage	V	1200	
Operational frequency (min...max)	Hz	45...65	
Rated operating current AC-51 (resistive load) at 40°C	A	40	
Rated operating current AC-51 (resistive load) at 55°C	A	35	
Heatsink for use at 40°C and 55°C at rated current AC-51	K/W	≤0.9	
Operational current min	A	0.05	
Non repetitive surge peak on state current t=10ms	A	500	
Off state leakage current	mA	1	
On state output voltage drop	V	1.5	
Critical rate of rise of off-state voltage dv/dt	V/μs	500	
Input - Output isolation	V	4000	
Input - Output to metal base	V	4000	
Output protection type	TVS		
I2t	A2s	1250	
<b>Terminal characteristics</b>			
Control terminals	Type	Screw M4	
Terminals tool	PZ2		
Tightening torque control terminals	Nm	1.2...2	
	Ibin	10.6...17.7	
Conductor section connectable (control terminals) with 1 or 2 wires min...max	AWG stranded	n°	18...14
	Flexible w/o lug	mm2	0.75...2.5
	Flexible c/w insulated spade lug	mm2	0.75...2.5
Load terminals	Type	Screw M5	
Load terminals tool	PZ2		
Tightening torque load terminals	Nm	2...3	
	Ibin	20.4	
Conductor section connectable (load terminals) with 1 or 2 wires min...max			

AWG stranded	n°	16...10
Flexible w/o lug	mm2	1.5...6
Flexible c/w insulated spade lug	mm2	1.5...6

Operating position	allowable	Any
Fixing		Screw

**Ambient conditions**

Temperature	Operating temperature	min	°C	-40
		max	°C	+90
	Storage temperature	min	°C	-40
		max	°C	+100

**Dimensions**

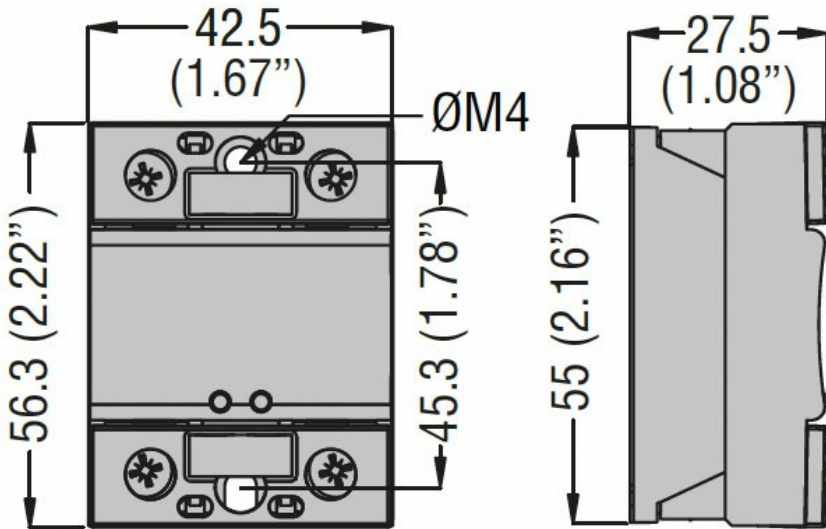

**Certifications and compliance**

Certifications	IEC/EN/BS 60335-1
	IEC/EN/BS 60947-4-2
	IEC/EN/BS 60947-4-3
	IEC/EN/BS 62314

Compliance	cURus
	VDE

**ETIM classification**

EC000066 - Power contactor, AC switching