



Coloane luminoase Ø50 mm
LTN50

Denumirea produsului

Denumirea tipului de produs

Caracteristici generale

Diametru mm - inch 50 / 1.97

Material Plastic

Caracteristici mecanice

Greutate g 76

Conditii ambientale

Temperatura

Temperatura de Operare

min °C -30
max °C +50

Dimensiuni

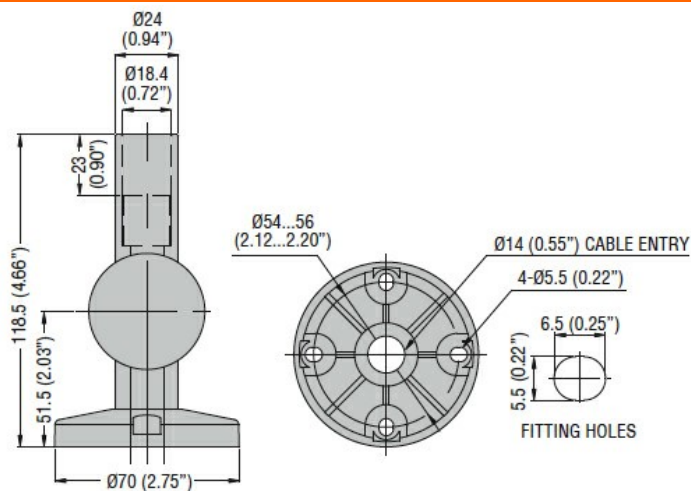

Certificari si conformitate

Conformitate

IEC/EN/BS 60947-1
IEC/EN/BS 60947-5-1

Clasificare ETIM

ETIM 8.0

EC001153 -
Suport de perete
pentru fixarea
coloanei de
semnalizare