



Denumirea produsului	Coloane iluminate Ø70 mm
Denumirea tipului de produs	8LT7C - Module de conectare

Caracteristici generale

Diametru	mm - inch	70 / 2.75
Culoare		Gri
grad de protectie IEC		IP65

Caracteristici mecanice

Cuplu de strângere pentru terminale max	Nm	0.5
Terminale Borne șurub		Borne cu clemă cu șurub

Secțiunea dirijorului	AWG/Kcmil		
		max	16
	IEC	max	mm ² 1.5
Greutate		g	110

Conditii ambientale

Temperatura	Temperatura de Operare		
		min	°C -20
		max	°C +50

Dimensiuni

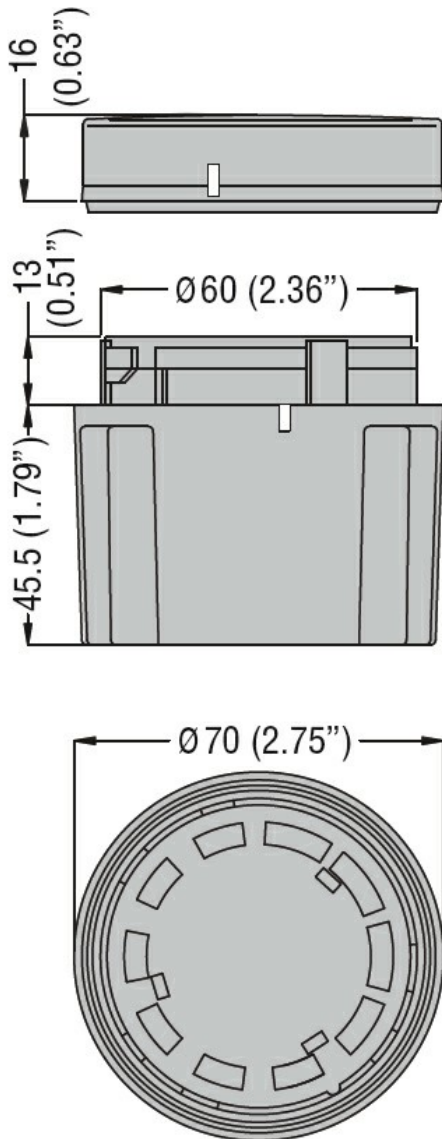

Diagrame de cablare

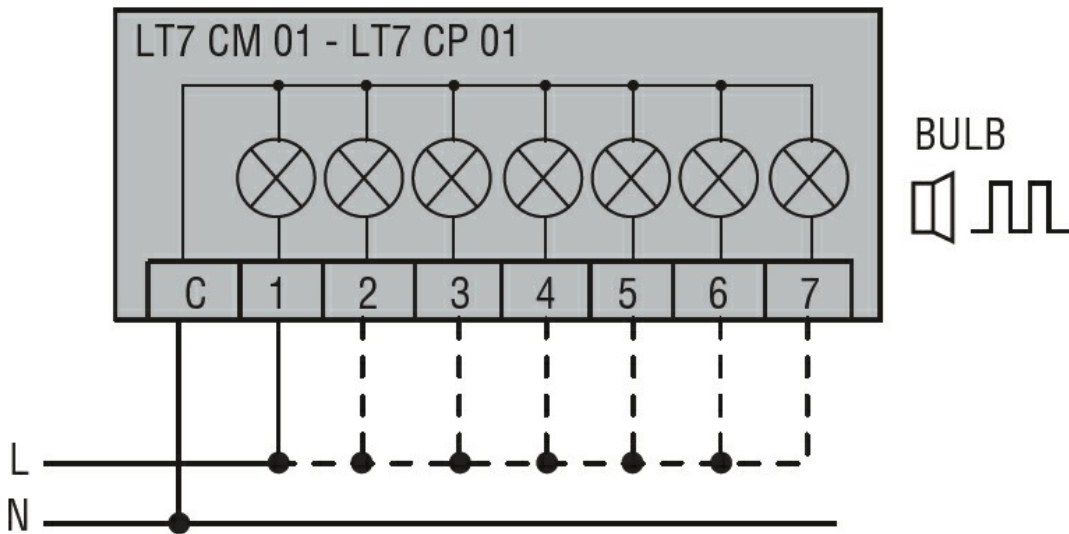

Connect terminals C and 1 as indicated to power the first module.
If other modules are fitted, the respective terminals must be
connected accordingly.

Certificari si conformitate

Conformitate

CSA C22.2 n°14

IEC/EN 60947-1

IEC/EN 60947-5-1

UL508

Certificate

cULus

EAC

Clasificare ETIM

ETIM 8.0

EC001152 -
Modul de
conectare pentru
coloana de
semnal