



Signal tower
Ø70mm/2.75"
LTN70

Product designation

Product type designation

General characteristics

Diameter	mm - inch	70 / 2.75
Supply voltage (AC)	V	110...230
IEC degree of protection		IP65
Power consumption	VA	1

Mechanical features

Terminals screw Spring terminals

Conductor section	AWG/Kcmil	min	16	
		max	24	
	IEC	min	mm ²	0.25
		max	mm ²	1.5

Weight g 277

Ambient conditions

Temperature	Operating temperature	min	°C	-30
		max	°C	+50

Dimensions

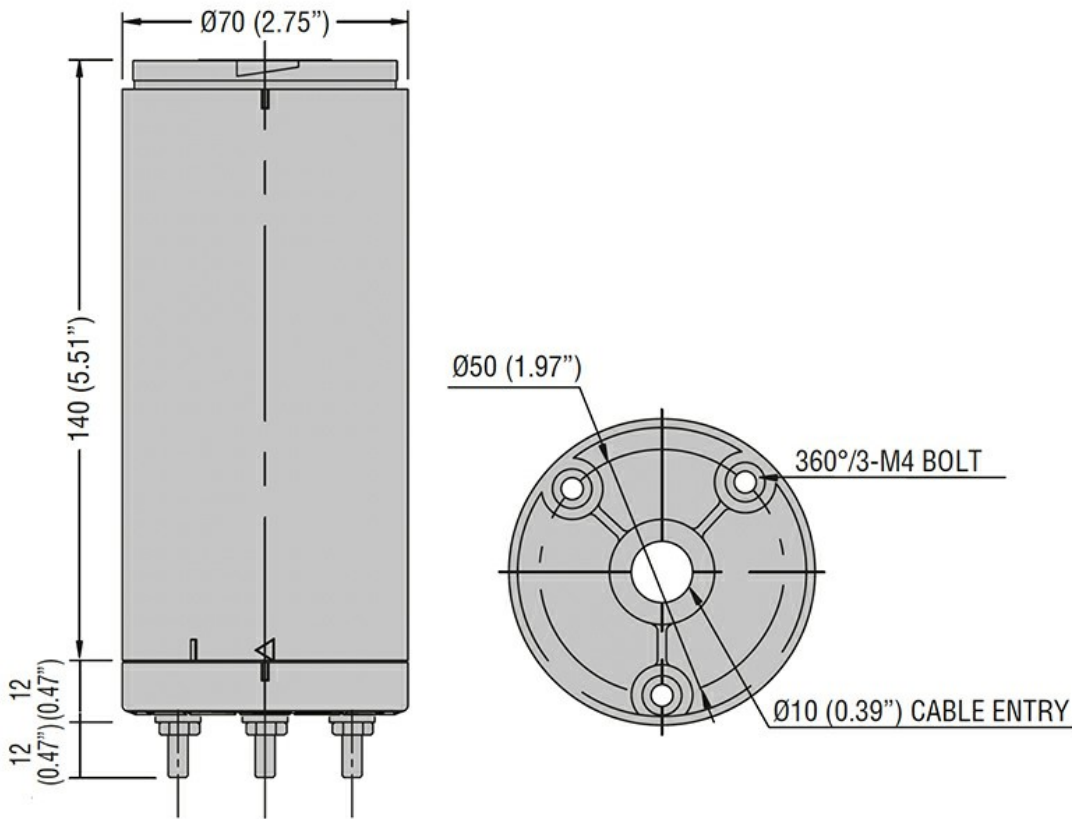

Certifications and compliance

Compliance

CSA C22.2 n° 14
IEC/EN/BS 60947-1
IEC/EN/BS 60947-5-1
UL508

Certificates

cULus

ETIM classification

ETIM 8.0

EC001154 -
Stand for signal
tower without
tube