



Signal tower  
Ø70mm/2.75"  
LTN70

Product designation

Product type designation

**General characteristics**

Diameter mm - inch 70 / 2.75

Material Plastic

**Mechanical features**

Weight g 94

**Ambient conditions**

Temperature

Operating temperature

min °C -30  
max °C +50

**Dimensions**

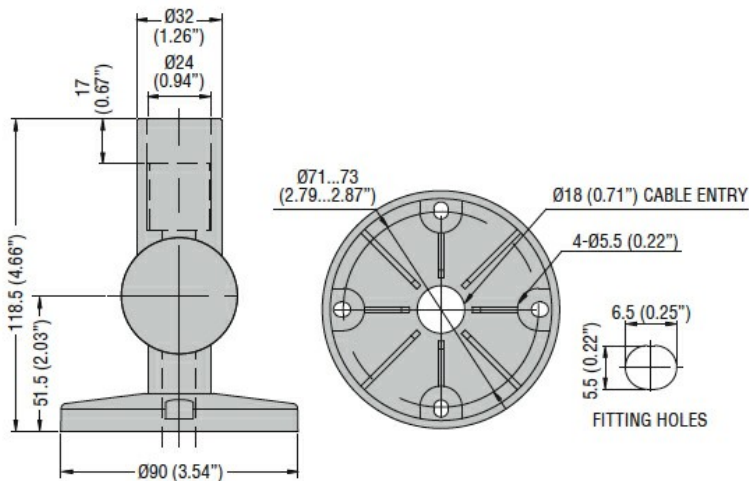

**Certifications and compliance**

Compliance

IEC/EN/BS 60947-1

IEC/EN/BS 60947-5-1

**ETIM classification**

ETIM 8.0

EC001153 - Wall  
bracket for signal  
tower