



Signal tower  
Ø50mm/1.97"  
LTN50

Product designation

Product type designation

**General characteristics**

Diameter mm - inch 50 / 1.97

Material Metal

**Mechanical features**

Weight g 72

**Ambient conditions**

Temperature

Operating temperature

|     |    |     |
|-----|----|-----|
| min | °C | -30 |
| max | °C | +50 |

**Dimensions**

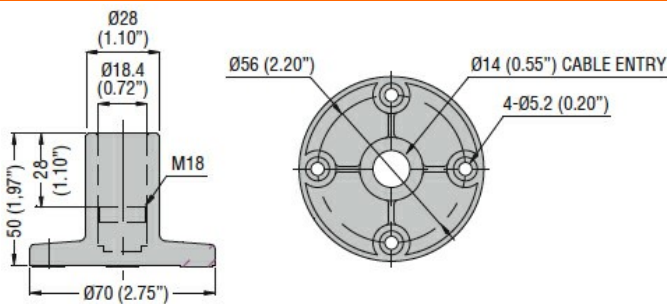

**Certifications and compliance**

Compliance

IEC/EN/BS 60947-1  
IEC/EN/BS 60947-5-1

**ETIM classification**

ETIM 8.0

EC001153 - Wall  
bracket for signal  
tower