



Product designation

Signal tower
Ø70mm/2.75"
8TL7GL - Light
modules

Product type designation

General characteristics

Diameter	mm - inch	70 / 2.75
Supply voltage (AC)	V	110...120
Colour		White
IEC degree of protection		IP65

Mechanical features

Weight	g	83
--------	---	----

Ambient conditions

Temperature	Operating temperature		
	min	°C	-20
	max	°C	+50

Dimensions

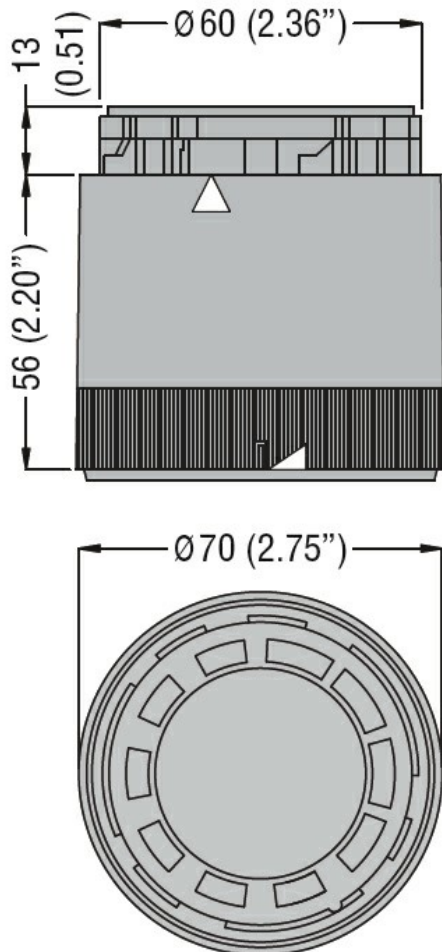

Wiring diagrams

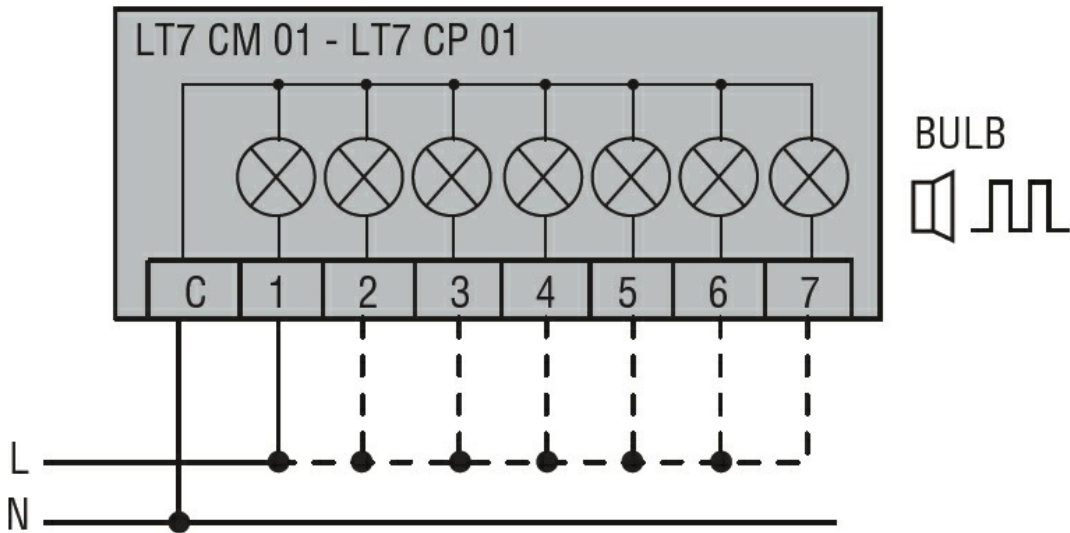

Connect terminals C and 1 as indicated to power the first module. If other modules are fitted, the respective terminals must be connected accordingly.

Certifications and compliance

Compliance

CSA C22.2 n° 14

IEC/EN 60947-1

IEC/EN 60947-5-1

UL508

Certificates

cULus

EAC

ETIM classification

ETIM 8.0

EC000232 -
 Optical module
 for signal tower