

Product designation				Rotary cam switches
Product type designation				GX20
<b>General characteristics</b>				
Switching diagram				07 - ON/OFF switch 3 poles
N° of elements				2
Mounting form				U11 - Front mounting with black handle without front plate for hole diam. 22mm fixing
<b>Contact characteristics</b>				
Rated insulation voltage $U_i$	IEC/EN	V	690	
	UL/CSA	V	600	
Rated impulse withstand voltage $U_{imp}$			kV	6
Conventional free air thermal current $I_{th}$	IEC/EN	A	20	
	UL/CSA	A	15	
Rated operational voltage			V	440
Rated operational impulse voltage			kV	4
Maximum fuse size for short-circuit protection $I_n$ (gG)	10kA	A	20	
	15kA	A	20	
	25kA	A	20	
Rated short time current $I_{cw}$			1s	kA
				250
Conductivity				10/5 mA/V
Operational current $I_e$ IEC/EN	AC1/AC21A			A
				20
AC15	110V	A	10	
	220/230V	A	8	
	380/400V	A	6	
	660/690V	A	1.5	
Rated operational power in AC	Three-phase AC-3			
	220/230V	kW	3.7	
	380/440V	kW	5.5	
	500/690V	kW	5.5	
	Single-phase AC-3			
	110V	kW	0.75	
	220/230V	kW	1.8	
	380/440V	kW	3	
	Three-phase AC23A			
	220/230V	kW	4	
	380/440V	kW	7.5	
	500/690V	kW	7.5	
Single-phase AC23A				
110V	kW	0.75		
220/230V	kW	2.2		

	380/440V	kW	3.5
Rated operational current in DC			
DC21A	48V	A	20
	60V	A	20
	110V	A	4
	220V	A	0.6
	440V	A	0.25
DC23A (poles in series)	24V	A	20 (1)
	48V	A	20 (2)
	60V	A	20 (3)
	110V	A	10 (3)
	220V	A	8 (4)
DC13	24V	A	20
	48V	A	16
	60V	A	12
	110V	A	1
	220V	A	0.4
	440V	A	0.15
Power dissipation		W	0.6
<b>Mechanical features</b>			
Terminals screw			M3
Tightening torque for terminals max		Nm	0.8
Conductor size			
AWG - Rigid cable	min	AWG	20
	Max	AWG	12
AWG - Flexible cable	min	AWG	20
	Max	AWG	12
Conductor size (IEC) - Flexible cable	min	mm <sup>2</sup>	0.5
	Max	mm <sup>2</sup>	2.5
Conductor size (IEC) - Rigid cable	min	mm <sup>2</sup>	0.5
	Max	mm <sup>2</sup>	2.5
Mechanical life		cycles	1X10 <sup>6</sup>
<b>UL technical data</b>			
Motor power for direct-on-line control			
for three-phase motor	120V	HP	1.5
	240V	HP	3
	480V	HP	5
	600V	HP	5
for single-phase motor	120V	HP	0.75
	240V	HP	1.5
<b>Ambient conditions</b>			
Temperature			
Operating temperature	min	°C	-25
	max	°C	+55

Storage temperature

min	°C	-40
max	°C	+70

Resistance & Protection

Frontal IP degree	IP65
Terminals IP degree	IP20

Dimensions

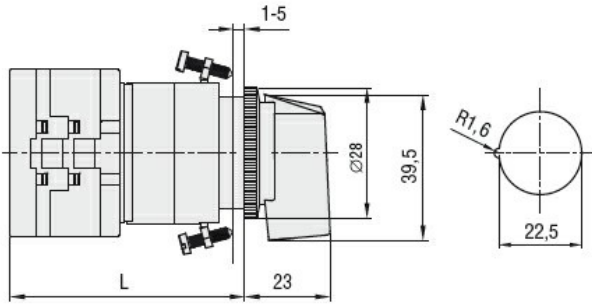

Series	L			
	1	2	3...8	
<b>GX16</b>	54	62.5	71	147.5
<b>GX20</b>	54	62.5	71	147.5

Wiring diagrams

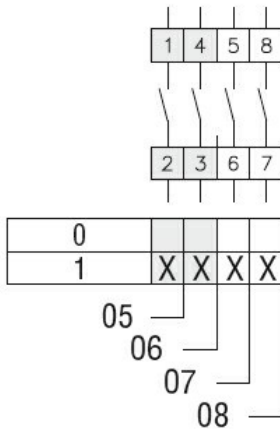

Certifications and compliance

Compliance

CSA C22.2 n° 14  
IEC/EN/BS 60947-1  
IEC/EN/BS 60947-3  
IEC/EN/BS 60947-5-1  
IEC/EN/BS 61058-1  
UL60947-4-1

Certificates

cULus  
EAC

ETIM classification

ETIM 8.0

EC001029 -  
Selector switch,  
complete