

Product designation				Rotary cam switches
Product type designation				GN200
General characteristics				
Switching diagram				13 - Dahlander motor control switch 1-0-2
N° of elements				4
Mounting form				U - Front mounting with black handle
Contact characteristics				
Rated insulation voltage U_i	IEC/EN	V	690	
	UL/CSA	V	600	
Rated impulse withstand voltage U_{imp}			kV	8
Conventional free air thermal current I_{th}	IEC/EN	A	200	
	UL/CSA	A	200	
Rated operational voltage			V	690
Rated operational impulse voltage			kV	6
Maximum fuse size for short-circuit protection I_n (gG)	10kA	A	200	
	15kA	A	200	
Rated short time current I_{cw}			1s	kA
				3300
Operational current I_e IEC/EN AC1/AC21A			A	200
Rated operational power in AC Three-phase AC-3	220/230V	kW	27.5	
	380/440V	kW	47	
Rated operational current in DC DC21A	48V	A	200	
	60V	A	200	
	110V	A	35	
	220V	A	2.5	
	440V	A	0.9	
Power dissipation			W	26
Mechanical features				
Terminals screw				M10
Tightening torque for terminals max				Nm 10
Conductor size	AWG - Rigid cable	Max	AWG	1X3
	AWG - Flexible cable	Max	AWG	0
	Conductor size (IEC) - Flexible cable	Max	mm ²	1X95
Conductor size (IEC) - Rigid cable	Max	mm ²	1X95	

Mechanical life cycles 2X10⁵

UL technical data

Motor power for direct-on-line control

for three-phase motor

120V	HP	30
240V	HP	50
480V	HP	100
600V	HP	75

for single-phase motor

120V	HP	15
240V	HP	30

Ambient conditions

Temperature

Operating temperature

min	°C	-25
max	°C	+55

Storage temperature

min	°C	-40
max	°C	+70

Resistance & Protection

Frontal IP degree

IP40

Terminals IP degree

IP00

Dimensions

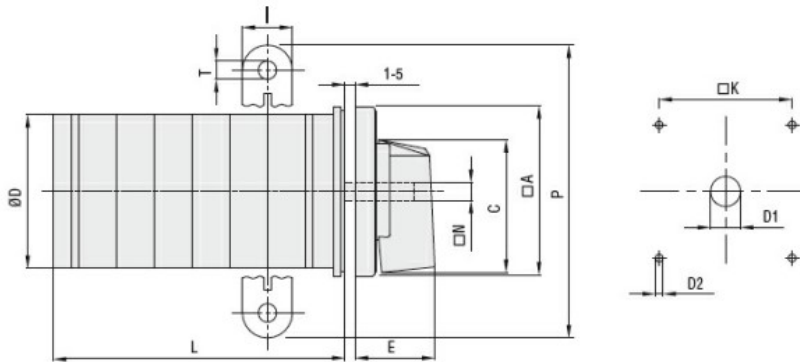

Series	Dimensions											L Number of elements ①											
	□A	C	ØD	ØD1	ØD2	E	I	□K	□N	P	ØT	1	2	3	4	5	6	7	8	9	10	11	12
GN200	132	104	120	16	5.3	56	20	104	10	140	10.5	77	107	136	166	196	226	284	314	343	373	402	432
GN315	132	104	120	16	5.3	56	20	104	10	145	10.5	77	107	136	166	196	226	284	314	343	373	402	432

① For devices with 6 or more elements please consult Technical support, see contact details on inside front cover.

Wiring diagrams

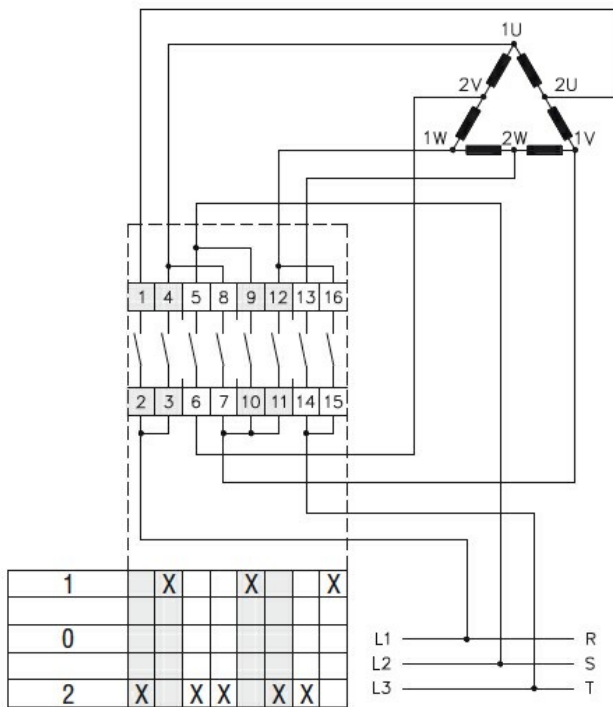

Certifications and compliance

Compliance

IEC/EN/BS 60947-1
IEC/EN/BS 60947-3
IEC/EN/BS 60947-5-1
UL60947-4-1

Certificates

UR

ETIM classification

ETIM 8.0

EC001029 -
Selector switch,
complete