

Product designation				Rotary cam switches
Product type designation				7GN20
General characteristics				
Switching diagram				06 - ON/OFF switch 2 poles
N° of elements				1
Mounting form				U25 - Front mounting with red/yellow handle padlockable in 0 and protection covers
Contact characteristics				
Rated insulation voltage U_i	IEC/EN	V	690	
	UL/CSA	V	600	
Rated impulse withstand voltage U_{imp}			kV	6
Conventional free air thermal current I_{th}	IEC/EN	A	20	
	UL/CSA	A	20	
Rated operational voltage			V	480
Rated operational impulse voltage			kV	4
Maximum fuse size for short-circuit protection I_n (gG)	10kA	A	20	
	15kA	A	16	
	25kA	A	16	
Rated short time current I_{cw}			1s	kA
				250
Conductivity				10/5 mA/V
Operational current I_e IEC/EN	AC1/AC21A			A
				20
AC15	110V	A	10	
	220/230V	A	8	
	380/400V	A	6	
	660/690V	A	1.5	
Rated operational power in AC	Three-phase AC-3			
	220/230V	kW	3	
	380/440V	kW	5.5	
	500/690V	kW	5.5	
	Single-phase AC-3			
	110V	kW	0.8	
	220/230V	kW	2.2	
	380/440V	kW	3	
	Three-phase AC23A			
	220/230V	kW	5	
	380/440V	kW	7.5	
	500/690V	kW	7.5	
Single-phase AC23A				
110V	kW	0.8		
220/230V	kW	2.5		

	380/440V	kW	3.7
Rated operational current in DC			
DC21A	48V	A	20
	60V	A	20
	110V	A	4
	220V	A	0.6
	440V	A	0.25
DC23A (poles in series)	24V	A	20 (1)
	48V	A	20 (2)
	60V	A	20 (3)
	110V	A	10 (3)
	220V	A	8 (4)
DC13	24V	A	20
	48V	A	16
	60V	A	12
	110V	A	1
	220V	A	0.4
	440V	A	0.15
Power dissipation		W	0.8
Mechanical features			
Terminals screw			M3
Tightening torque for terminals max		Nm	0.5
Conductor size			
AWG - Rigid cable	min	AWG	20
	Max	AWG	12
AWG - Flexible cable	min	AWG	20
	Max	AWG	14
Conductor size (IEC) - Flexible cable	min	mm ²	0.5
	Max	mm ²	2.5
Conductor size (IEC) - Rigid cable	min	mm ²	0.5
	Max	mm ²	2.5
Mechanical life		cycles	5x10 ⁶
UL technical data			
Motor power for direct-on-line control			
for three-phase motor	120V	HP	1.5
	240V	HP	3
	480V	HP	7.5
	600V	HP	10
for single-phase motor	120V	HP	0.75
	240V	HP	2
Ambient conditions			
Temperature			
Operating temperature	min	°C	-25
	max	°C	+55

Storage temperature

min °C -40
max °C +70

Resistance & Protection

Frontal IP degree IP40
Terminals IP degree IP00

Dimensions

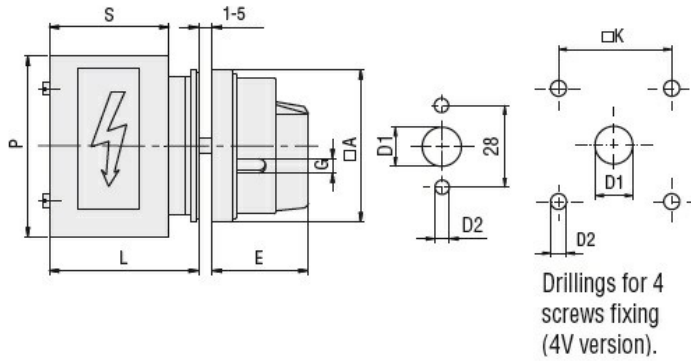

Series	Dimensions								
	□A	D1	D2	E	G	□K	S	P	L
7GN12	65	12	5	34.2	5	36	43	64	54.3
7GN20	65	12	5	34.2	5	36	43	64	54.3
7GN25	65	12	5	34.2	5	36	51	68	62.6
7GN32	65	14	5	38	6	48	55	77	71.7
7GN40	65	14	5	38	6	48	55	77	71.7

Wiring diagrams

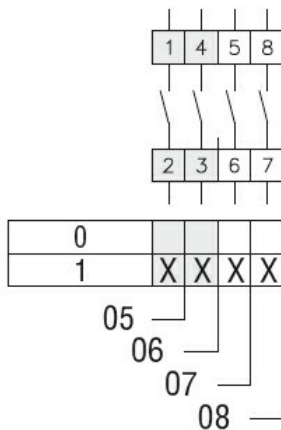

Certifications and compliance

Compliance

CSA C22.2 n° 14
IEC/EN/BS 60947-1
IEC/EN/BS 60947-3
IEC/EN/BS 60947-5-1
UL60947-4-1

Certificates

cCSAus
EAC
UL

ETIM classification

ETIM 8.0

EC001105 - Off-load switch