



Denumirea produsului	Selector iluminat - 3 poziții
Denumirea tipului de produs	LPCSL13

#### Caracteristici generale

Culoare	Verde
Tipul posturilor	Selector
Material	Poliamidă
grad de protectie IEC	IP66, IP67 și IP69K

#### Caracteristici mecanice

Durata de viata mecanica	cycles	1000000
Fixare	Fara baza de fixare	
Adaptor de montare	LPXAU120	
Greutate	g	25

#### Date tehnice UL

Grad de protectie UL	Tip 1, 2, 3R, 4, 4X, 12, 12K
----------------------	---------------------------------

#### Conditii ambientale

##### Temperatura

##### Temperatura de Operare

min	°C	-25
max	°C	+70

##### Temperatura de depozitare

min	°C	-40
max	°C	+85

#### Dimensiuni

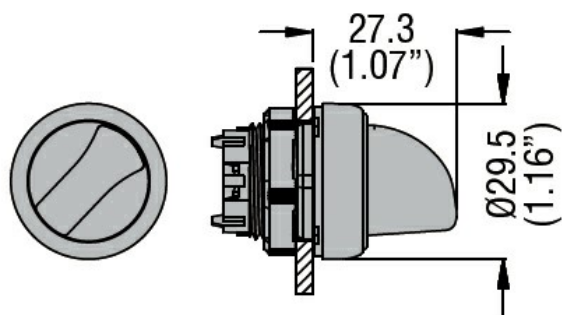

#### Certificari si conformitate

##### Conformitate

CSA C22.2 n° 14  
IEC/EN/BS 60947-1  
IEC/EN/BS 60947-5-1  
UL508

##### Certificate

CCC  
cULus

---

EAC

---

RINA

Clasificare ETIM

ETIM 8.0

EC000222 -  
Element frontal  
pentru comutator  
selector