



Denumirea produsului	Selector cheie - 3 pozitii
Denumirea tipului de produs	LPCS39

Caracteristici generale

Culoare	Negru
Tipul posturilor	1 - 0 < 2, extragerea cheii în 1
Material	Poliamidă
grad de protectie IEC	IP66, IP67 și IP69K

Caracteristici mecanice

Durata de viata mecanica	cycles	1000000
Adaptor de montare		LPXAU120
Greutate	g	60

Date tehnice UL

Grad de protectie UL	Tip 1, 2, 3R, 4, 4X, 12, 12K
----------------------	------------------------------

Conditii ambientale

Temperatura

Temperatura de Operare

min	°C	-25
max	°C	+70

Temperatura de depozitare

min	°C	-40
max	°C	+85

Dimensiuni

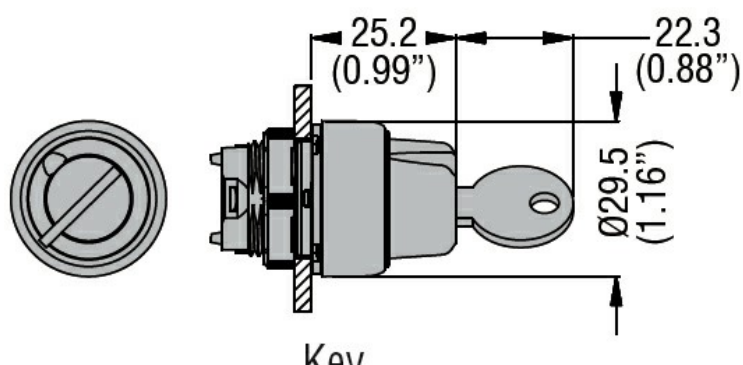

Certificari si conformitate

Conformitate

CSA C22.2 n° 14
IEC/EN/BS 60947-1
IEC/EN/BS 60947-5-1
UL508

Certificate

CCC

cULus

Clasificare ETIM

ETIM 8.0

EC000222 -
Element frontal
pentru comutator
selector