



Denumirea produsului	Selector cheie - 3 pozitii
Denumirea tipului de produs	LPCS38

Caracteristici generale

Culoare	Negru
Tipul posturilor	Selector
Material	Poliamidă
grad de protectie IEC	IP66, IP67 și IP69K

Caracteristici mecanice

Durata de viata mecanica	cycles	1000000
Adaptor de montare		LPXAU120
Greutate	g	60

Date tehnice UL

Grad de protectie UL	Tip 1, 2, 3R, 4, 4X, 12, 12K
----------------------	------------------------------

Conditii ambientale

Temperatura

Temperatura de Operare

min	°C	-25
max	°C	+70

Temperatura de depozitare

min	°C	-40
max	°C	+85

Dimensiuni

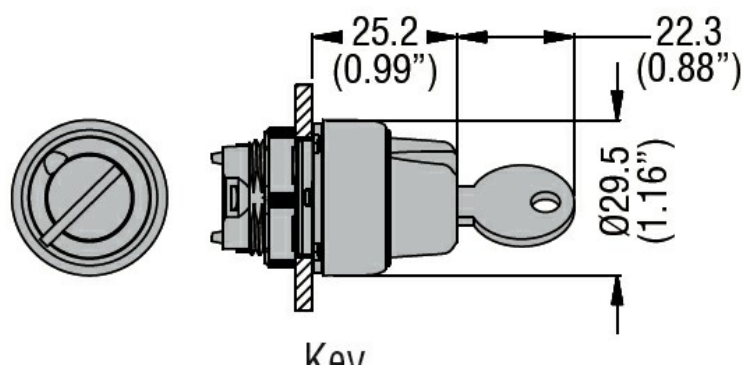

Certificari si conformitate

Conformitate

CSA C22.2 n° 14
IEC/EN/BS 60947-1
IEC/EN/BS 60947-5-1
UL508

Certificate

CCC
cULus

Clasificare ETIM

ETIM 8.0

EC000222 -
Element frontal
pentru comutator
selector