



Denumirea produsului	Selector cheie - 2 pozitii
Denumirea tipului de produs	LPCS34

Caracteristici generale

Culoare	Negru
Tipul posturilor	Selector
Material	Poliamidă
grad de protectie IEC	IP66, IP67 și IP69K

Caracteristici mecanice

Durata de viata mecanica	cycles	1000000
Adaptor de montare		LPXAU120
Greutate	g	60

Date tehnice UL

Grad de protectie UL	Tip 1, 2, 3R, 4, 4X, 12, 12K
----------------------	------------------------------

Conditii ambientale

Temperatura	Temperatura de Operare	min	°C	-25
		max	°C	+70
	Temperatura de depozitare	min	°C	-40
		max	°C	+85

Dimensiuni

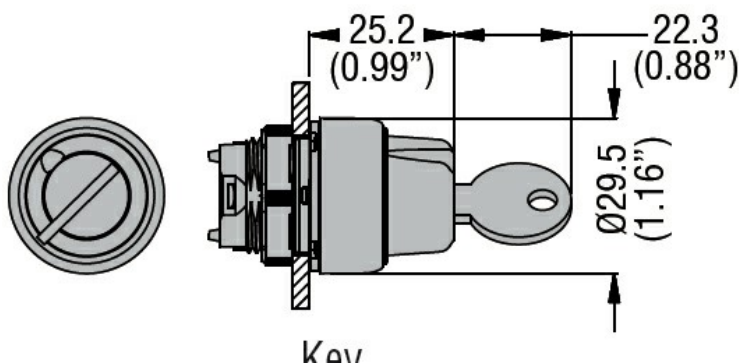

Certificari si conformitate

Conformitate	CSA C22.2 n° 14
	IEC/EN/BS 60947-1
	IEC/EN/BS 60947-5-1
	UL508
Certificate	CCC
	cULus

Clasificare ETIM

ETIM 8.0

EC000222 -
Element frontal
pentru comutator
selector