



Plastic control station without actuators - for 5 actuators
LPZP5A8

Product designation

Product type designation

General characteristics

Colour Grey

Material Polycarbonate

IEC degree of protection IP66, IP67, IP69K

Mechanical features

Tightening torque for terminals max Nm 1.8

Weight g 240

UL technical data

UL degree of protection 1, 2, 3R, 4, 4X, 12K

Ambient conditions

Temperature

Operating temperature

min	°C	-25
max	°C	+70

Storage temperature

min	°C	-40
max	°C	+85

Dimensions

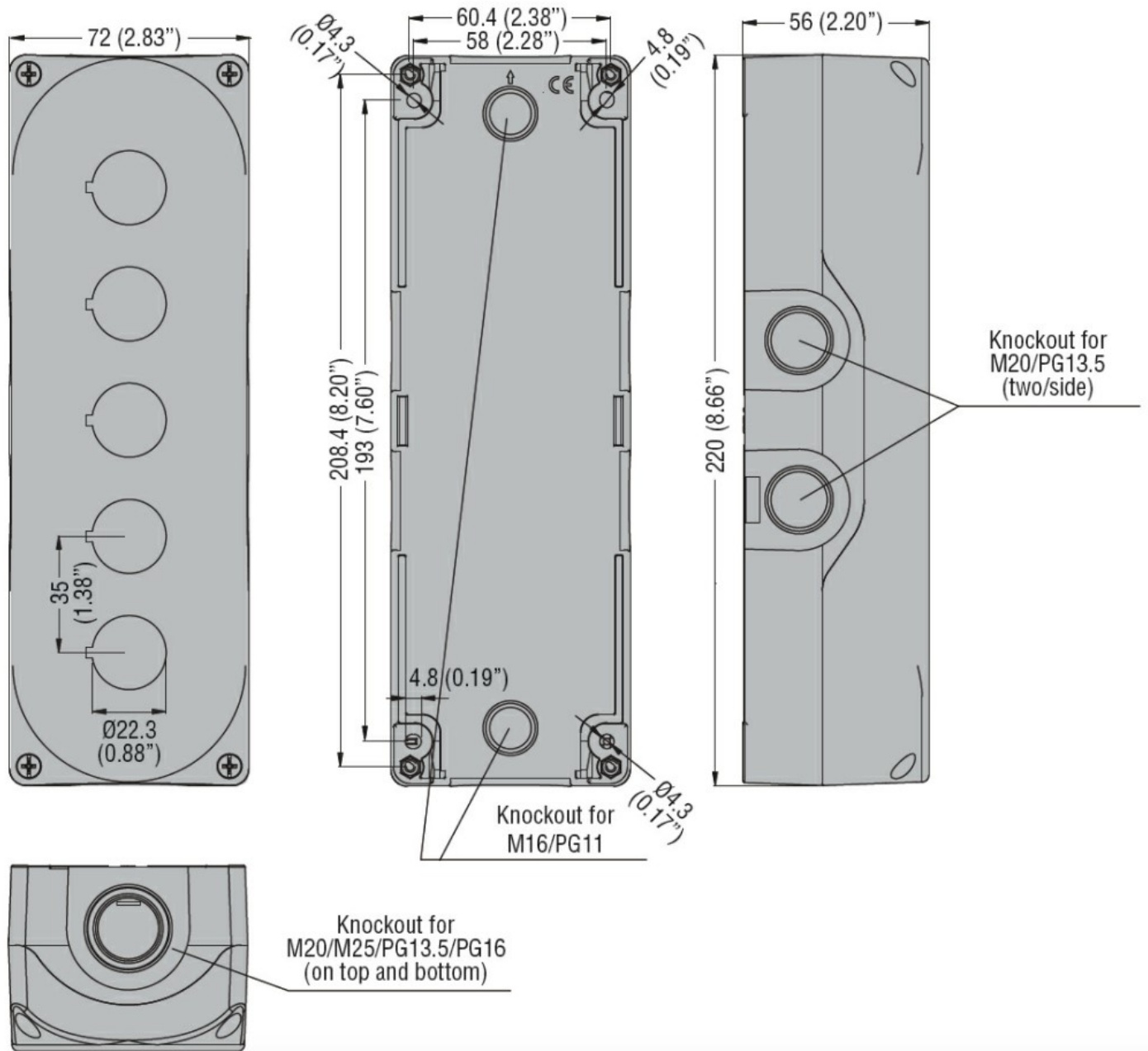

Certifications and compliance

Compliance

CSA C22.2 n° 14
IEC/EN 60947-1
IEC/EN 60947-5-1
UL508

Certificates

cULus
EAC

ETIM classification

ETIM 8.0

EC000200 -
Enclosure for
control circuit
devices