



Plastic control station with one actuators - Grey, 1 way LPZP1A8 LPZP1B802

Product designation

Product type designation

General characteristics

Colour	Grey
Type of positions	Mushroom head pushbutton
Material	Polycarbonate
IEC degree of protection	IP66, IP67, IP69K

Mechanical features

Tightening torque for terminals max	Nm	1.8
Weight	g	135

Ambient conditions

Temperature	Operating temperature	min	°C	-25
		max	°C	+70
	Storage temperature	min	°C	-40
		max	°C	+85

Dimensions

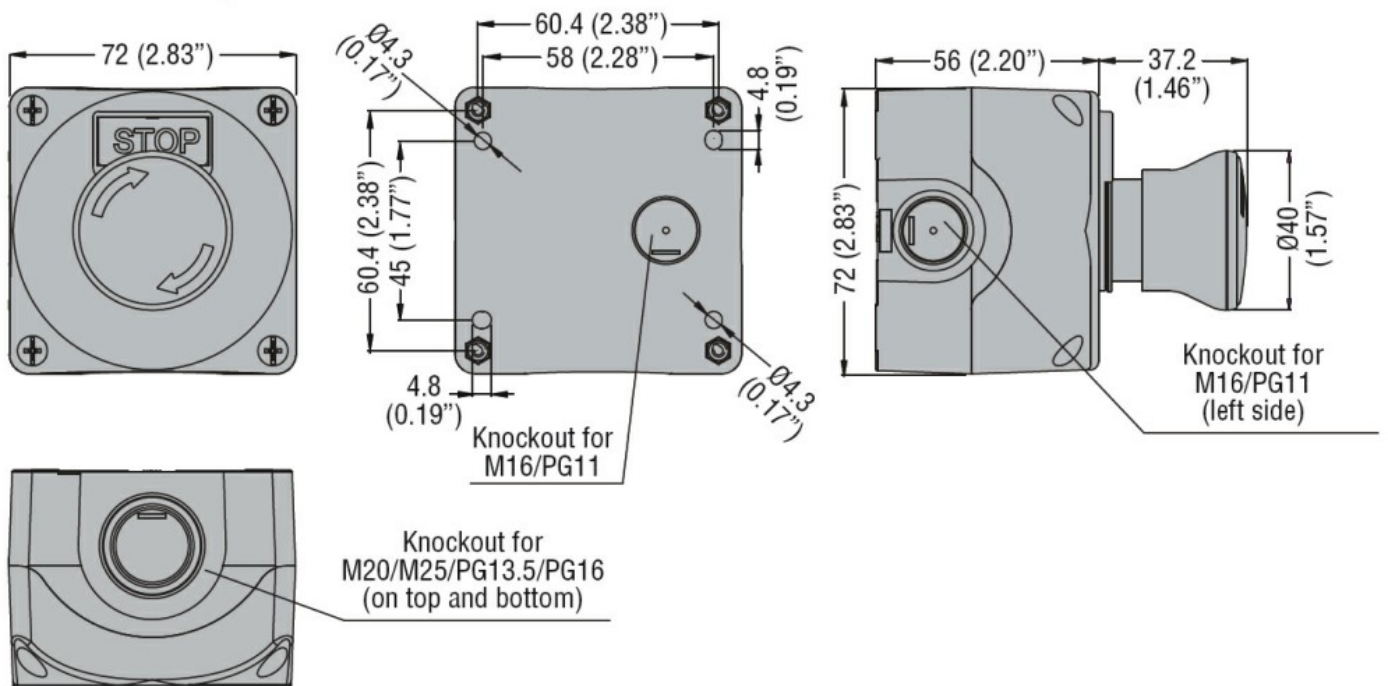

Wiring diagrams

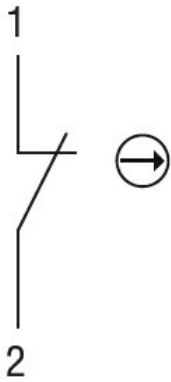

Certifications and compliance

Compliance

CSA C22.2 n° 14

IEC/EN 60947-1

IEC/EN 60947-5-1

UL508

Certificates

cULus

EAC

ETIM classification

ETIM 8.0

EC000200 -
Enclosure for
control circuit
devices