



Enclosures with cut-outs for Ø22mm units - with hole for 6 actuators
LPZM

Product designation

Product type designation

General characteristics

Colour Grey

IEC degree of protection IP66 and IP67

Mechanical features

Weight g 671

UL technical data

UL degree of protection NEMA 4X

Ambient conditions

Temperature

Operating temperature

min °C -25
max °C +70

Storage temperature

min °C -40
max °C +85

Dimensions

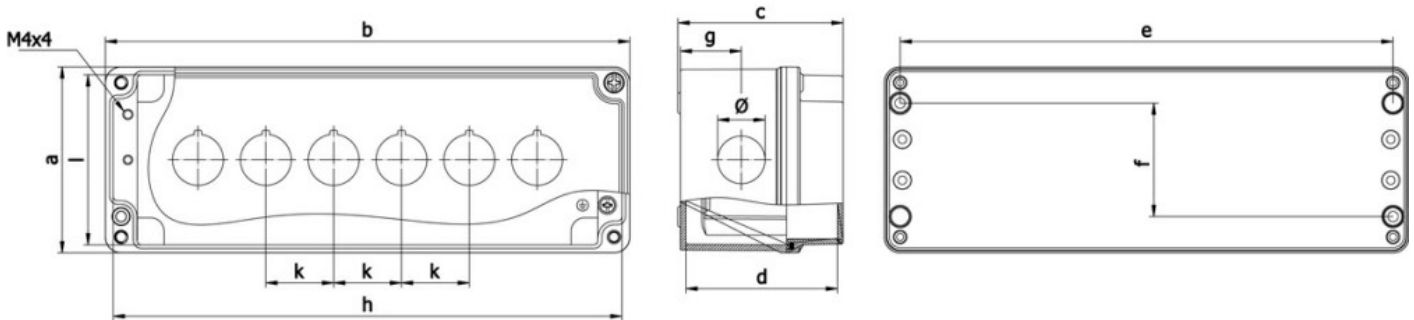

a	b	c	d	e	f	g	h	l	k	Ø
80	230	73	67	218	50	27	225	75	30	21

Certifications and compliance

Compliance

CSA C22.2 n° 14

IEC/EN 60947-1

IEC/EN 60947-5-1

UL508

Certificates

cULus

EAC

ETIM classification

ETIM 8.0

EC000200 -
Enclosure for
control circuit
devices