



LED elements
steady light with
spring-clamp
terminals
LPXLP

Product designation

Product type designation

General characteristics

Colour White

Electrical characteristics

Rated frequency Hz 50-60

Supply voltage (AC) V 85...140

Operations

Electrical life hours 100000

Mechanical features

Conductor section

AWG/kcmil conductor section

max 14

IEC

max mm² 1 or 2 / 2.5

Mounting adapter LPXAU120

Weight g 15

Ambient conditions

Temperature

Operating temperature

min °C -25

max °C +70

Storage temperature

min °C -40

max °C +85

Dimensions

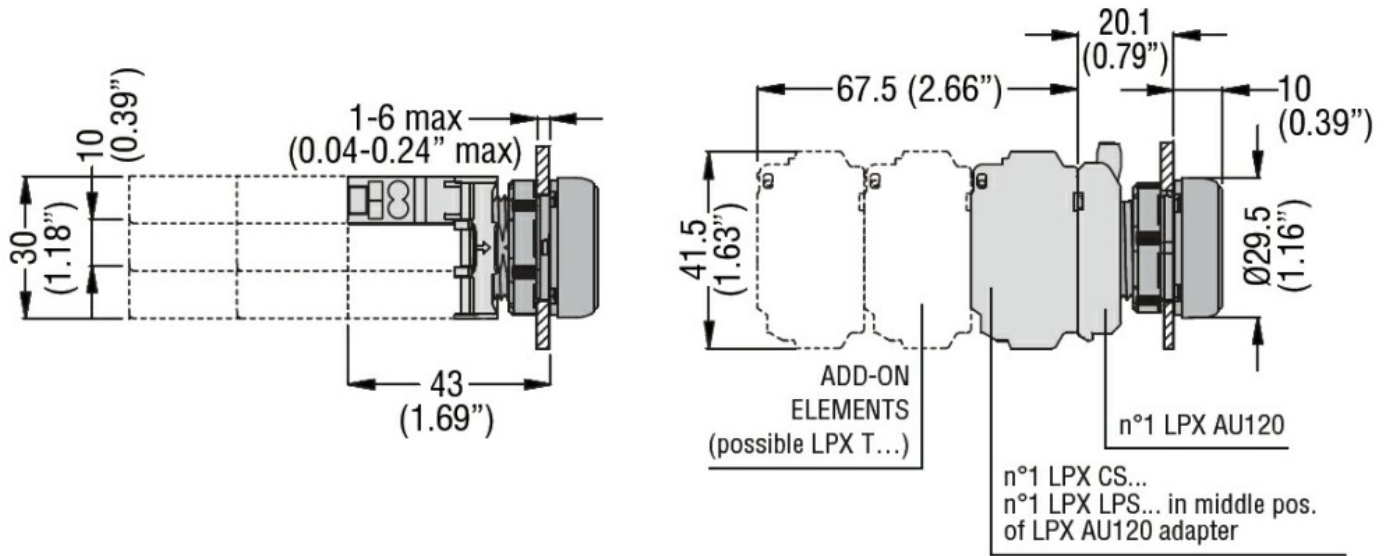

Wiring diagrams

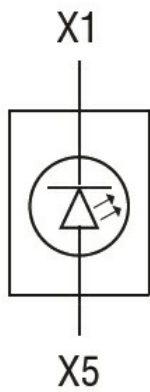

Certifications and compliance

Compliance

CSA C22.2 n° 14
IEC/EN/BS 60947-1
IEC/EN/BS 60947-5-1
UL508

Certificates

CCC
cULus
EAC
RINA
UL

ETIM classification

ETIM 8.0

EC000204 -
Lamp holder
block for control
circuit devices