

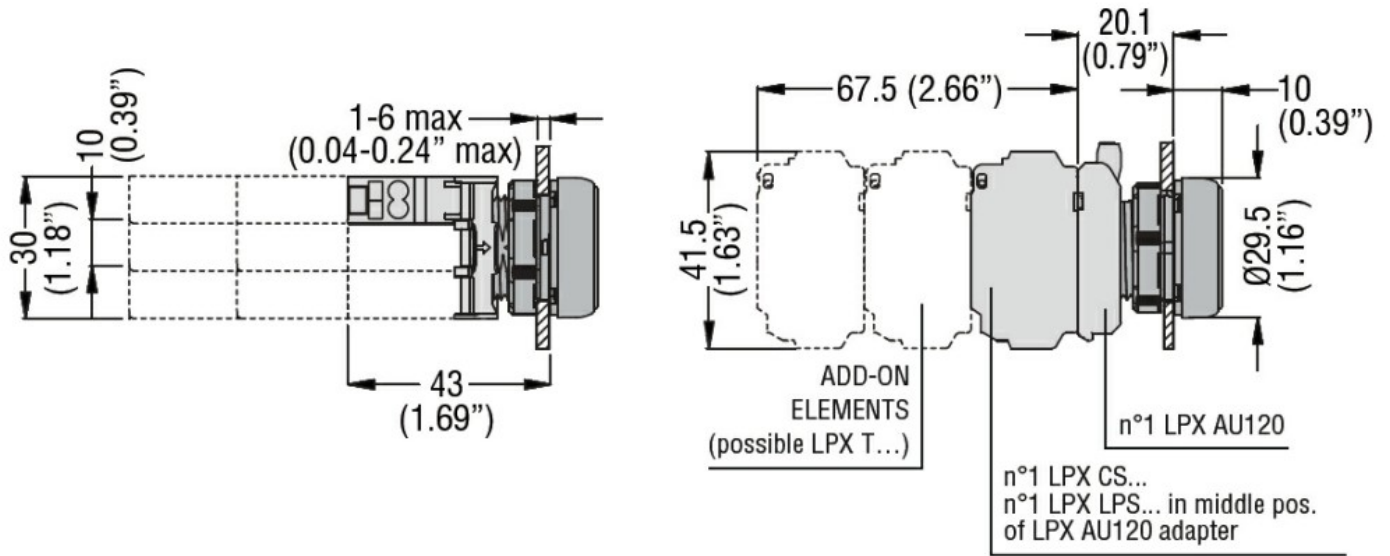

Product designation				LED elements steady light with spring-clamp terminals
Product type designation				LPXLP
General characteristics				
Colour				Green
Electrical characteristics				
Rated frequency		Hz	50-60	
Supply voltage (AC)		V	12...30	
Operations				
Electrical life		hours	100000	
Mechanical features				
Conductor section	AWG/kcmil conductor section			
		max	14	
	IEC			
		max	mm ²	1 or 2 / 2.5
Mounting adapter				LPXAU120
Weight		g	15	
Ambient conditions				
Temperature	Operating temperature			
		min	°C	-25
		max	°C	+70
	Storage temperature			
		min	°C	-40
		max	°C	+85
Dimensions				



Wiring diagrams



Certifications and compliance

Compliance

CSA C22.2 n° 14
IEC/EN/BS 60947-1
IEC/EN/BS 60947-5-1
UL508

Certificates

CCC
cULus
EAC
RINA
UL

ETIM classification

ETIM 8.0

EC000204 -
Lamp holder
block for control
circuit devices