



Product designation

LED elements
steady light
LPXLE

Product type designation

General characteristics

Colour

Green

Electrical characteristics

Supply voltage (AC)

V 12...30

Supply voltage (DC)

V 12...30

Operations

Electrical life

hours 100000

Mechanical features

Tightening torque for terminals max

Nm 1

Conductor section

AWG/kcmil conductor section

max 12

IEC

max mm² 1 or 2 / 2.5

Mounting adapter

LPXAU120

Weight

g 16

Ambient conditions

Temperature

Operating temperature

min °C -25
max °C +60

Storage temperature

min °C -40
max °C +85

Dimensions

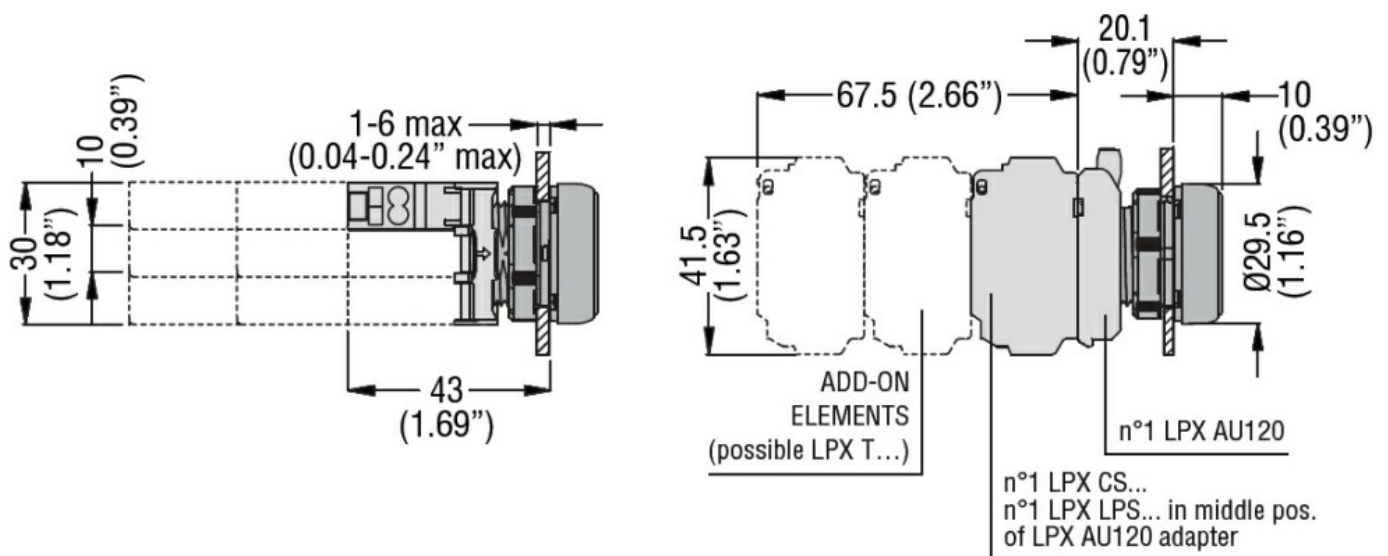

Wiring diagrams



Certifications and compliance

Compliance

CSA C22.2 n° 14
IEC/EN/BS 60947-1
IEC/EN/BS 60947-5-1
UL508

Certificates

CCC
cULus
EAC
RINA
UL

ETIM classification

ETIM 8.0

EC000204 -
Lamp holder
block for control
circuit devices