



Illuminated disk
for mushroom
head
pushbuttons
LPXDAU

Product designation

Product type designation

General characteristics

Colour Yellow

Electrical characteristics

Supply voltage (AC) V 220...240

Mechanical features

Operating position

allowable Any

Weight g 22

Ambient conditions

Temperature

Operating temperature

min °C -25
max °C +60

Storage temperature

min °C -40
max °C +85

Dimensions

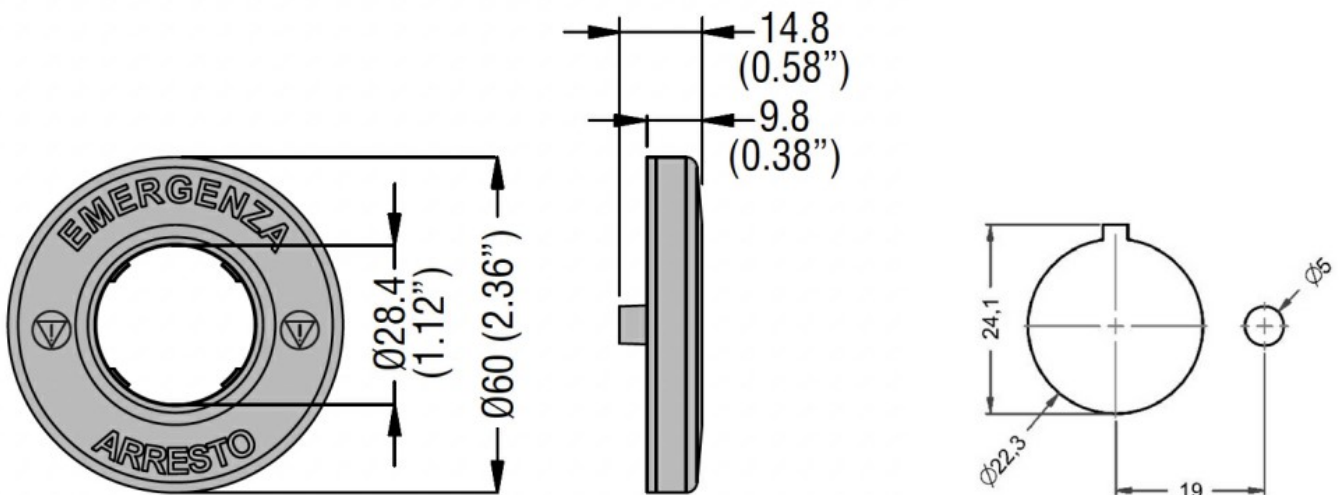

Wiring diagrams

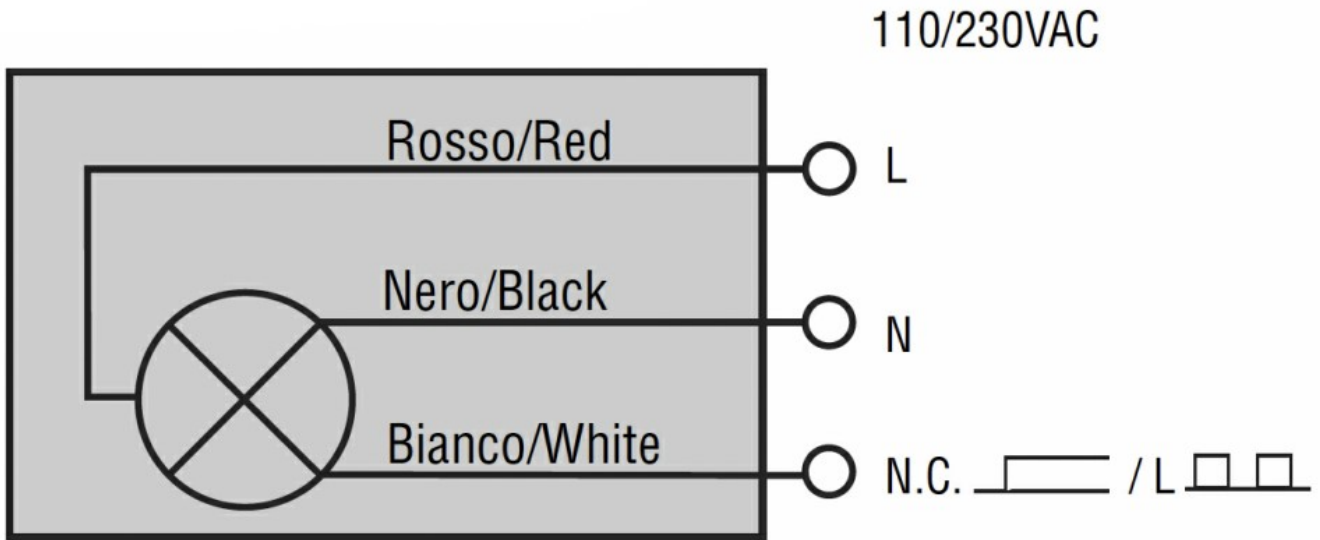

Certifications and compliance

Compliance

CSA C22.2 n° 14

IEC/EN 60947-1

IEC/EN 60947-5-1

UL508

Certificates

EAC