



Label holder for engraved plastic LPX AU108 label LPXAU105

Product designation

Product type designation

Mechanical features

Weight

g 3

Dimensions

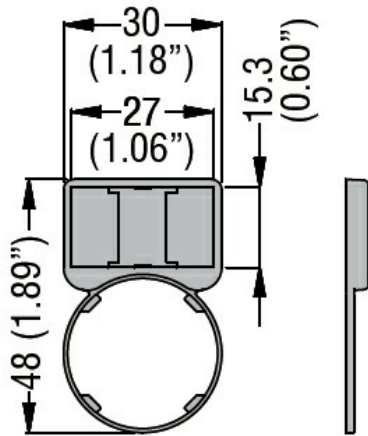

Certifications and compliance

Compliance

/

Certificates

/

ETIM classification

ETIM 8.0

EC001032 - Text plate holder for command devices