

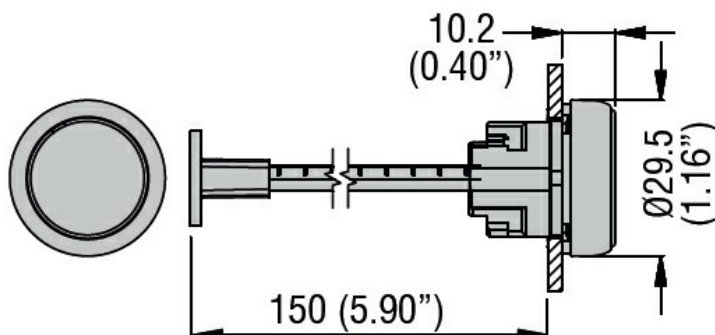

Product designation	Mechanical reset buttons, complete unit, spring return LPSR10		
Product type designation	LPSR10		
General characteristics			
Colour	Blue		
Type of positions	Mechanical reset button		
Material	Aluminium and zinc alloy for metal parts and polyamide for plastic parts		
IEC degree of protection	IP66, IP67 and IP69K		
Mechanical features			
Mechanical life	cycles	5000000	
Fixing	Without mounting adapter		
Mounting adapter	LPXAU120M		
UL technical data			
UL degree of protection	Type1, 2, 3R, 4, 4X, 12, 12K		
Ambient conditions			
Temperature	Operating temperature		
	min	°C	-25
	max	°C	+70
	Storage temperature		
	min	°C	-40
	max	°C	+85

Dimensions



Certifications and compliance

Compliance

CSA C22.2 n° 14

IEC/EN/BS 60947-1

IEC/EN/BS 60947-5-1

UL508

Certificates

cULus

ETIM classification

ETIM 8.0

EC000029 -
Push-switch
button