

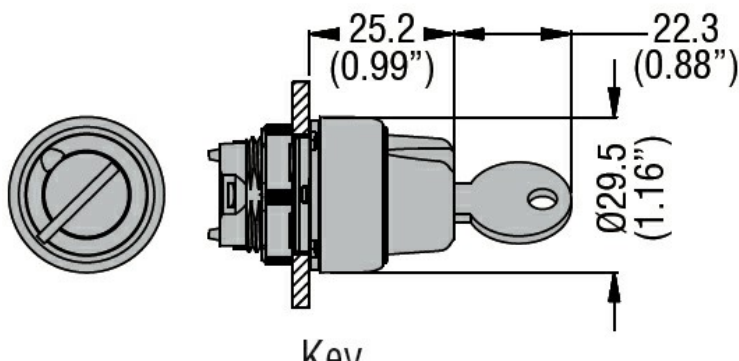

Product designation	Selector switch actuator key - 3 position		
Product type designation	LPCS33		
<b>General characteristics</b>			
Colour	Black		
Type of positions	1 - 0 - 2, key extraction in 2		
Material	Polyamide		
IEC degree of protection	IP66, IP67 and IP69K		
<b>Mechanical features</b>			
Mechanical life	cycles	1000000	
Mounting adapter	LPXAU120		
Weight	g	60	
<b>UL technical data</b>			
UL degree of protection	Type1, 2, 3R, 4, 4X, 12, 12K		
<b>Ambient conditions</b>			
Temperature	Operating temperature		
	min	°C	-25
	max	°C	+70
	Storage temperature		
	min	°C	-40
	max	°C	+85

**Dimensions**



**Certifications and compliance**

Compliance

CSA C22.2 n° 14  
IEC/EN/BS 60947-1  
IEC/EN/BS 60947-5-1  
UL508

Certificates

CCC

---

cULus

ETIM classification

ETIM 8.0

EC000222 -  
Front element for  
selector switch