



Product designation	Pushbutton actuators, spring return, with symbol
Product type designation	LPCB15

**General characteristics**

Colour	Black
Type of positions	Flush pushbutton
Material	Polyamide
IEC degree of protection	IP66, IP67 and IP69K

**Mechanical features**

Operating force	kg-lb	<0.5Kg / 1.1lb
Mechanical life	cycles	5000000
Fixing		Without mounting adapter
Mounting adapter		LPXAU120
Weight	g	25

**UL technical data**

UL degree of protection	Type1, 2, 3R, 4, 4X, 12, 12K
-------------------------	------------------------------

**Ambient conditions**

Temperature	Operating temperature	min	°C	-25
		max	°C	+70
	Storage temperature	min	°C	-40
		max	°C	+85

**Dimensions**

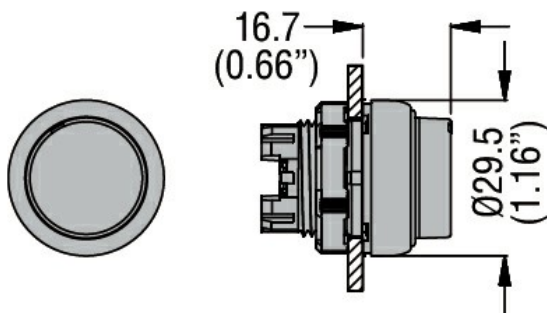

**Certifications and compliance**

Compliance	CSA C22.2 n° 14
	IEC/EN/BS 60947-1
	IEC/EN/BS 60947-5-1

---

UL508

---

Certificates

CCC

---

cULus

---

EAC

---

RINA

ETIM classification

ETIM 8.0

EC000221 -  
Front element for  
push button