



Product designation	Monoblock actuators		
Product type designation	LMPB6		
General characteristics			
Colour	Red		
Type of positions	Monoblock mushroom head		
IEC degree of protection	IP66 on front, IP20 on terminals		
Electrical characteristics			
Rated insulation voltage U_i IEC/EN	V	400	
IEC Conventional free air thermal current I_{th}	A	8	
UL/CSA and IEC/EN 60947-5-1 designation	B300 R300		
Operating current AC12	12V	A	8
	24V	A	8
	120V	A	8
	240V	A	6
	380V	A	3.8
Operating current AC15	12V	A	8
	24V	A	8
	120V	A	6
	240V	A	3
	380V	A	1.9
Operating current DC12	12V	A	2.5
	24V	A	2.5
	125V	A	1.1
	250V	A	0.55
	400V	A	0.3
Operating current DC13	12V	A	2.5
	24V	A	2.5
	125V	A	0.55
	250V	A	0.27
	400V	A	0.15
Operations			
Electrical life	cycles	100000	
Mechanical features			
Mechanical life	cycles	300000	
Conductor section	AWG/kcmil conductor section		
	min	26	
	max	16	
IEC			

min	mm ²	0.2
max	mm ²	1.5

UL technical data

UL degree of protection

Type 1, 4X indoor and 13

Ambient conditions

Temperature

Operating temperature

min	°C	-25
max	°C	+70

Storage temperature

min	°C	-40
max	°C	+85

Dimensions

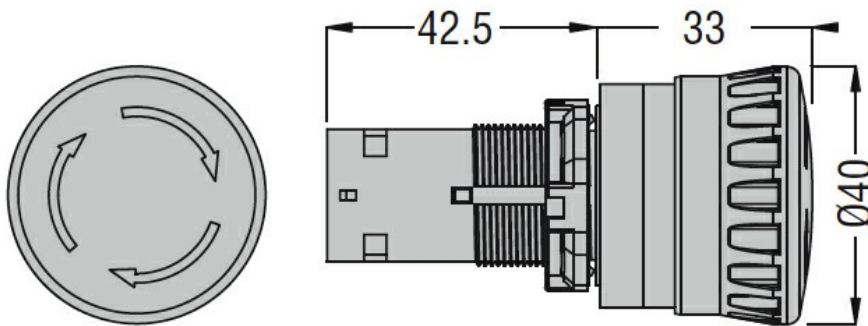

Wiring diagrams

